



# **RACING RULES & REGULATIONS**

**V.25/26.2**

## **SPEEDWAY AUSTRALIA'S MISSION STATEMENT**

- To create an environment in which Speedway Australia and its licence holders, clubs and other stakeholders can flourish in developing and expanding the sport of speedway in Australia.
- To encourage, facilitate and support participation in accessible, sustainable and safer speedway.
- To ensure fair, consistent and professional standards

## **SPEEDWAY AUSTRALIA'S CORE TASKS**

- Licensing of competitors and tracks
- Complimentary insurance for competitors
- Public liability insurance for tracks
- Racing rules and personal safety equipment
- Track inspections and minimum operating standards
- Night of Champions: Australian Speedway Awards + Hall of Fame
- Kids to Grids and Speed Clinic Junior Development Programs
- Rising Star Elite Athlete Program
- Racing Officials Training
- Grant Assistance and Operational Grants for venues

## **SPEEDWAY AUSTRALIA'S SCOPE OF OPERATIONS**

- Head Office based in Adelaide
- A team of 7 staff members based around the country
- Not for profit organisation with a Committee of Management of 7
- Licence 96 venues
- Over 15,000 licence holders
- Recognise 76 divisions



## **AFFILIATED ORGANISATIONS**

- Nine National Divisional Bodies (e.g. SSA, SCCA, Speedcars Australia)
- State Divisional Bodies
- Australasian Speedway Promoters Association
- NSW Office of Sport
- Motorsport Australia

**This Duty of Care Statement is to be read out to the Drivers at every Drivers' & Racing Officials/Marshals Briefing before the start of any Race Meeting with no exceptions starting with the following introduction:**

"My name is ..... and I hold a current Speedway Australia Racing Officials card." (Hold up Racing Officials card or phone app for drivers to see)

It is my duty to advise you of the following;

- That motor racing can be dangerous; your equipment could be damaged or destroyed; and you may suffer serious personal injury or worse.
- If there is any aspect of this Race Meeting that causes you concern for your personal safety or for that of any member of your crew, whether that concern be with the Race Track, the venue or the manner in which the Race Meeting is being conducted it is your obligation to bring those concerns to the attention of the Clerk of the Course/Race Director or Chief Steward.
- If after doing this those concerns are not addressed to your satisfaction, you are advised to withdraw from this Race Meeting.

Does everyone understand his or her obligations and rights in this regard?

**It is also my duty to advise that the Speedway Australia Drug and Alcohol Policy is to be upheld and enforced and at any time during this Race Meeting you may be subjected to a random drug and/or alcohol test. Should you fail such a test, you will then be subject to the relevant penalties as per the Speedway Australia Racing Rules and Regulations.**

**Does anyone have any questions?**

---

**At race meetings with SCCA classes present, the final paragraph should read: It is also my duty to advise that the Speedway Australia and SCCA Drug and Alcohol Policies are to be upheld and enforced and at any time during this Race Meeting you may be subjected to a random drug and/or alcohol test. Should you fail such a test, you will then be subject to the relevant penalties as per the Speedway Australia or SCCA Racing Rules or Regulations.**

**Head Office:** 287 Payneham Road  
Royston Park  
South Australia 5070

**Postal Address:** PO Box 269  
Stepney  
South Australia 5069

**Phone:** 08 8139 0777

**Email:** [admin@speedwayaustralia.net.au](mailto:admin@speedwayaustralia.net.au)  
**Website:** [www.speedwayaustralia.org](http://www.speedwayaustralia.org)

# 08 8139 0777

WWW.SPEEDWAYAUSTRALIA.ORG



**SPEEDWAY**  
AUSTRALIA

**DOWNLOAD  
THE APP**

Available on the  
**App Store**

GET IT ON  
**Google Play**

As a not-for-profit organisation, Speedway Australia exists to meet the needs of our stakeholders in our favourite sport.

We are passionate about and committed to the entire speedway community, and the vast majority of our staff are speedway people who have got lucky by being able to enjoy their hobby on a full-time basis.

Similarly, our governance team is reflective of the speedway community with a broad range of experienced leaders who represent the entire country through geographic spread and representation of the groups who make up the sport.

Speedway Australia doesn't charge an affiliation fee, and works hard to which to offer most of our products and services at no cost to venue operators, clubs and divisional bodies.

Some of the services we offer at no cost include track inspections, Racing Officials training, this rulebook, Sport Development Officer assistance, the Track Operators Manual, Safety & Operational Grants, Grant application assistance, the Kids to Grids, Speed Clinic and Rising Star Initiatives and National title support.

Want to know more? Contact the office to be directed to the right person who can assist you.





**SPRINTCARS**  
AUSTRALIA

All Sprintcar racing for SCCA registered Sprintcars in Australia will be conducted under the current SCCA Racing Rules, Regulations and Specifications book.

SCCA will enforce the Speedway Australia Pit Rules and Speedway Australia Occupational Health and Safety Rules at Speedway Australia affiliated venues where SCCA registered Sprintcar competitions is being conducted through SCCA and its State/Territory member clubs and other affiliate bodies.

The Speedway Australia Drug and Alcohol Policy is to be upheld and enforced for all except for SCCA conducted Sprintcar racing, where either the Speedway Australia Drug and Alcohol Policy, or the SCCA Drug and Alcohol Policy will apply.

### **More Information: 410ci and 360-LS Sprintcars**

Email: [secretary@sprintcarsaustralia.com](mailto:secretary@sprintcarsaustralia.com)  
Website: [sprintcarworld.au](http://sprintcarworld.au)  
Rules: [Technical Specifications & Racing Rules](#)  
SCCA on [Facebook](#)



### **More Information: Wingless Sprints**

Email: [secretary@awsr.com.au](mailto:secretary@awsr.com.au)  
Website: [www.awsr.com.au](http://www.awsr.com.au)  
Rules: [Technical Specifications](#)  
AWSR on [Facebook](#)



Email: [office@speedwaysedans.com](mailto:office@speedwaysedans.com)  
Website: [www.speedwaysedans.com](http://www.speedwaysedans.com)  
SSA on: [Facebook](#)

### Speedway Sedans Australia Technical Specs:

[Junior Sedans](#)  
[National 4's](#)  
[Street Stocks](#)

[Modified Sedans](#)  
[Production Sedans](#)  
[Super Sedans](#)



Email: [amcanationals@gmail.com](mailto:amcanationals@gmail.com)  
Website: [www.amcanationals.com.au](http://www.amcanationals.com.au)  
Rules: [Technical Specifications](#)  
AMCA Nationals on [Facebook](#)



Email: [g.mbxter@bigpond.com](mailto:g.mbxter@bigpond.com)  
Website: [formula500.com.au](http://formula500.com.au)  
Rules: [Technical Specifications](#)



Website: [v8dirtmodifieds.com.au](http://v8dirtmodifieds.com.au)  
Rules: [Technical Specifications](#)  
Dirt Modifieds Australia on [Facebook](#)



Email: [modlitesaustralia@outlook.com](mailto:modlitesaustralia@outlook.com)  
Website: [www.modlitesaustralia.com.au](http://www.modlitesaustralia.com.au)  
Rules: [Technical Specifications](#)  
Modlites Australia on [Facebook](#)



Email: [secretary@skaa.org.au](mailto:secretary@skaa.org.au)  
Website: [www.skaa.org.au](http://www.skaa.org.au)  
Rules: [Technical Specifications](#)  
Visit SKAA on [Facebook](#)



Email: [craig@racintyres.com](mailto:craig@racintyres.com)  
Rules: [Technical Specifications](#)  
LMA on: [Facebook](#)



Email: [speedcarsaus@gmail.com](mailto:speedcarsaus@gmail.com)  
Website: [speedcarsaustralia.com/](http://speedcarsaustralia.com/)  
Rules: [Technical Specifications](#)  
Speedcars Australia on [Facebook](#)



Email: [avcsnb@outlook.com](mailto:avcsnb@outlook.com)  
Vintage/Classic Speedway on [Facebook](#)

<b>DUTY OF CARE STATEMENT</b>	<b>2</b>
<b>CONTACT DETAILS</b>	<b>3</b>
<b>ABOUT US</b>	<b>4</b>
<b>SPRINTCAR RACING</b>	<b>5</b>
<b>NATIONAL DIVISIONS</b>	<b>6</b>
<b>DEFINITIONS</b>	<b>12</b>
<b>SECTION 1 - ADMINISTRATIVE / GENERAL REQUIREMENTS</b>	<b>19</b>
1.1. COMPLIANCE AUTHORITY	19
1.2. DISCLAIMER	19
1.3. VARIATION OR DEVIATION FROM THESE RULES	20
1.4. SUPPLEMENTARY REGULATIONS	20
1.5. SUPERSEDED RULES	21
<b>SECTION 2 - PRE RACE REQUIREMENTS</b>	<b>22</b>
2.1. NOMINATIONS	22
2.2. LICENCES	22
2.3. NEW DRIVERS	26
2.4. JUNIOR RACING	26
<b>SECTION 3 - TECHNICAL &amp; SAFETY</b>	<b>27</b>
3.1. RACE CAR REGISTRATIONS AND LOG BOOKS	27
3.2. RACE CAR COMPLIANCE	27
3.3. SAFETY EQUIPMENT & PROTECTIVE CLOTHING	28
3.4. MIRRORS & COMMUNICATION EQUIPMENT	30
3.5. NOISE CONTROL	30
3.6. MINIMUM FIRE SAFETY STANDARDS	31
3.7. PIT HEALTH & SAFETY	31
<b>SECTION 4 - RACE PROCEDURES</b>	<b>34</b>
4.1. FLAG, LIGHT AND BOARD SIGNALS	34
4.2. DIRECTION OF RACING	36
4.3. DUMMY GRID LINE UP	36
4.4. PUSH STARTS	36
4.5. RACE STARTS	36
4.6. STARTING OPTION	37
4.7. BREAKING FORMATION / JUMPING THE START	38
4.8. RECKLESS OR DANGEROUS DRIVING	38
4.9. PASSING	39
4.10. RACE TRACK RE-ENTRY	39
4.11. RACE INCIDENTS AND STOPPAGES	40
4.12. COMPLETE RESTARTS	41
4.13. RESTARTS	41
4.14. WARNING FLAG	43
4.15. REAR OF FIELD	43
4.16. REAR OF FIELD OFFENCES	43
4.17. BLACK FLAG	44

4.18.	BLACK FLAG (DISQUALIFICATION) OFFENCES	44
4.19.	DROPPING OF DEBRIS	44
4.20.	LAPPED CARS	44
4.21.	STOPPING ON TRACK TO FORCE A STOPPAGE	45
4.22.	GETTING OUT OF CAR	45
4.23.	COMPLETION OF A RACE	46
4.24.	FEATURE RACES DECLARED SHORT	47
4.25.	MECHANICAL DEFECTS	47
4.26.	WORKING ON CARS	48
4.27.	UNAUTHORISED ENTRY TO RACE TRACK	49
4.28.	REFUELLING	49
4.29.	SUBSTITUTE CARS	49
4.30.	NATIONAL TITLES & SERIES & STATE TITLES	50
4.31.	FIELD SIZES	51
4.32	PRACTICE PERMIT CONDITIONS	51
4.33	POLE LINE DEFINITION	51
<b>4.34</b>	<b>LINE MARKING</b>	<b>51</b>

## **SECTION 5 - RACING OFFICIALS AND THEIR DUTIES 52**

5.1.	RECOGNITION OF RACING OFFICIALS	52
5.2	ELIGIBILITY & CONFLICT OF INTERESTS	54
5.3.	CHIEF STEWARD	54
5.4.	DRIVER'S/RACING OFFICIALS BRIEFING	55
5.5.	CHIEF SCRUTINEER	56
5.6.	SCRUTINEERING	56
5.7.	INDEMNIFICATION OF SCRUTINEERS	57
5.8.	CLERK OF THE COURSE/RACE DIRECTOR	57
5.9.	RACE SECRETARY	58
5.10.	ASSISTANT STEWARDS & OFFICIAL OBSERVERS	58
5.11.	LAP SCORERS/TRANSPONDER OPERATORS	59
5.12.	DRIVERS REPRESENTATIVE	59

## **SECTION T 6 - DRUGS AND ALCOHOL 60**

6.1.	SA DRUG AND ALCOHOL POLICY	60
6.2.	PROCEDURE FOR DRUG TESTING	61
6.3.	PROHIBITED SUBSTANCES	62
6.4.	PROCEDURE FOR ALCOHOL TESTING	62
6.5.	POSSESSION OF ALCOHOL	63
6.6.	PENALTIES	63

## **SECTION 7 - BEHAVIOUR, FINES, PENALTIES & PROTESTS 64**

7.1.	INFRINGEMENT NOTICE	64
7.2.	VERBAL AND PHYSICAL ABUSE	66
7.3.	CONTROL OF PIT CREW	68
7.4.	RECIPROCAL CONDUCT	68
7.5.	MISCONDUCT – AT RACE MEETING	68
7.6.	MISCONDUCT – CHARGE BROUGHT BY SA	69
7.7.	INFRINGEMENT NOTICE OFFENCES/PENALTIES	71
7.8.	PROTESTS	71
7.9.	TECHNICAL	71
7.10.	FINES AND PENALTIES	72

<b>SECTION 8 - JUDICIAL PROCEDURES</b>	<b>73</b>
8.1. APPEAL AGAINST AN INFRINGEMENT NOTICE	73
8.2. DISCIPLINARY TRIBUNAL	74
8.3. SPEEDWAY APPEAL TRIBUNAL	75
8.4. TRIBUNAL PROCEDURE	77
<b>SECTION 9 - DEMOLITION DERBY</b>	<b>79</b>
9.1 – 9.11 DERBY RULES AND REGULATIONS	79
9.12 – 9.17.DERBY RACING RULES	83
<b>SECTION 10 - VINTAGE DEMONSTRATION RULES</b>	<b>90</b>
10.1 VINTAGE DEMONSTRATION RULES	90
<b>SECTION 11 - BURNOUT RULES AND REGULATIONS</b>	<b>91</b>
11.1 – 11.2.SAFETY REQUIREMENTS & DRIVERS	91
11.3. DRUGS AND ALCOHOL	91
11.4. VEHICLES	92
11.5. PIT AREA/INFIELD	93
11.6. BURNOUT PAD	93
11.7. COMPETITION RULES & BURNOUT CLASSES	93
<b>SECTION 12 - FORMS</b>	<b>95</b>
12.1. APPEAL FORM	96
12.2. REQUEST FOR DISCIPLINARY TRIBUNAL	98
12.3. REQUEST FOR SPEEDWAY APPEAL TRIBUNAL	100
<b>SECTION 13 - PENALTIES GUIDELINES</b>	<b>102</b>
13.1. PENALTY GUIDELINES	102
<b>SECTION 14 - MINIMUM SAFETY STANDARDS</b>	<b>103</b>
14.1. SEATBELTS	105
<b>SECTION 15 - SAFETY APPAREL AA, SSA &amp; A (OPEN WHEEL)</b>	<b>106</b>
<b>SECTION 16 - SAFETY APPAREL: A (SEDANS), SSA, B, JD &amp; V</b>	<b>107</b>
<b>SECTION 17 - SAFETY APPAREL: KARTS</b>	<b>109</b>

## **APPENDIX 1-7: RULE VARIATIONS**

<b>APPENDIX 1: ALL SPRINTCARS</b>	<b>110</b>
<b>APPENDIX 2: SPEEDCARS</b>	<b>113</b>
<b>APPENDIX 3: SSA</b>	<b>114</b>
<b>APPENDIX 3B: RSA &amp; AMCA</b>	<b>118</b>
<b>APPENDIX 3C: LMA</b>	<b>120</b>
<b>APPENDIX 4: SKAA KARTS</b>	<b>121</b>
<b>APPENDIX 5: FORMULA 500</b>	<b>123</b>
<b>APPENDIX 6: V8 DIRT MODIFIEDS</b>	<b>125</b>
<b>APPENDIX 7: LIGHTNING SPRINTS</b>	<b>126</b>

## **APPENDIX 8: PENALTY MATRIX**

<b>APPENDIX 8: PENALTIES MATRIX</b>	<b>127</b>
-------------------------------------	------------

## **NATIONAL INFORMATION 141**

ORGANISATIONAL STRUCTURE	142
GROUP PERSONAL INJURY INSURANCE	143
PUBLIC LIABILITY INSURANCE	144
GETTING INVOLVED IN SPEEDWAY	145
CODE OF CONDUCT	146
SOCIAL MEDIA	147
COMMUNICATIONS	148
ONLINE LICENCING	149
LICENCE FEES 2024/25	150
ONE DAY PIT LICENCES	151
SFI FOUNDATION	152
SPEEDWAY SAFETY COMMITTEE	153
TRACK RATING SYSTEM	154
AUSTRALIAN CHAMPIONS	155
GRANTS	156
HALL OF FAME	157
AUSTRALIAN SPEEDWAY AWARDS	158

## **STATE INFORMATION 159**

NEW SOUTH WALES & ACT	160
NORTHERN TERRITORY	161
QUEENSLAND	162
SOUTH AUSTRALIA	163
TASMANIA	164
VICTORIA	165
WESTERN AUSTRALIA	166

## **WHAT THE TEXT COLOURS MEAN**

### **New rules or changes**

**Green text – V. 24/25.1 released July 2024**

**Light Blue text – V. 24/25.2 released September 2024**

**Orange text – V25/26.1 released July 2025**

### **Affiliated Association**

An association or organisation which Speedway Australia recognises as an affiliated association and includes all associations managing the Racing Divisions endorsed by Speedway Australia that are included on the web site [www.speedwayaustralia.org](http://www.speedwayaustralia.org) and listed under "National Racing Divisions".

### **Appellant**

A person aggrieved by a decision under these rules, who seeks to appeal that decision in accordance with Section 8 of these rules.

### **Basic Tools**

Battery operated drill, bolt cutters, cable ties, chisels, crowbars, hacksaw, hammers, race tape, reciprocating saw and tin snips.

### **Baulk Line**

Has the definition described under Appendix 4 – Rule Variations, SKAA Karts.

### **Chief Scrutineer**

The person appointed Chief Scrutineer of a Race Meeting in accordance with rule 5.4 of these rules.

### **Chief Steward**

The person appointed as the Chief Steward of a Race Meeting in accordance with rule 5.2 of these rules.

### **Chief Steward Report**

The report required to be completed and submitted to the Track Operator by the Chief Steward at the end of every Race Meeting in the form set out at Section 12.

### **Clerk of the Course/Race Director**

The person whose duties are set out in rule 5.7 of these rules.

### **Club**

An organisation with the main purpose of providing services for its members who participate and or have an interest in the sport of speedway.

### **Competitor**

A Participant that is competing at a Race Meeting, including a Driver, Pit Crew Member and Race Car Owner but excluding a Racing Official or Marshal.

**Day Licence**

A licence which allows a Driver to compete for one single night of a Race Meeting.

**Defendant**

Has the meaning ascribed to it under rule 7.1.1 of these rules.

**Disciplinary Tribunal**

The tribunal established under Rule 8.1 or Rule 8.2 of these rules.

**Disqualification/Exclusion from Event**

These are interchangeable terms meaning that a competitor is excluded from particular Race results and is not entitled to any points or prize money in respect of that Race.

**Drivers'/Racing Officials Briefing**

A meeting of Drivers conducted by the Chief Steward to be held prior to every Race Meeting in accordance with rule 5.3 of these rules.

**Driver's Representative**

The person whose duties are set out in rule 5.11 of these rules.

**Driver**

The holder of a Licence to drive in an Event.

**Event**

Any Race, time trial, qualifying, hot lap, warm up, practice or other programmed session involving one or more Race Cars or any combination of the foregoing and includes scrutineering of Race Cars for such sessions.

**Enclosed Shoes**

Shoes which are flat with minimal heel, that have good grip, fit well and are fully enclosed/covered around the entire foot, including the top of the foot and heel. Shoes with large perforations or straps in the uppers (such as "croc" style shoes or sandals) are not permissible.

**Finish Line**

Where transponders are used the position of the transponder loop determines the finish line and this line extends from the outer edge of the Race Track to the edge of the Infield. Where transponders are not used the finish line will be determined by the Chief Steward.

**Fire Marshal**

A Marshal who is trained in the use of fire suppression equipment.

**Host Club**

A Club or Affiliated Association that conducts a Race Meeting. Within the case of an Event which is run by Speedway Australia (e.g. World Series Sprintcars) the Host Club shall be Speedway Australia.

## **Good Behaviour Period**

A good behaviour period or probation period is defined as a length of time set by a Chief Steward, Tribunal or Speedway Australia Head Office where a licence holder must not breach any Speedway Australia Racing Rule or Regulation within that period. If a rule breach during this period is identified by Speedway Australia an additional penalty will be applied to the licence holder.

## **Infield**

The area inside the Race Track.

## **Infield Marshal**

A Marshal who officiates in the Infield.

## **Infringement Card**

A card which the controlling body of a Racing Division may require competing drivers to hold and to keep with their Licence for the purpose of recording breaches of these rules and other infringements.

## **Infringement Notice**

A written notice served by the Chief Steward or nominee on any Licence Holder to notify the Licence Holder of an offence punishable by Disqualification, a fine and/or a period of Suspension including any directive that the Licence Holder is to be brought before the Disciplinary Tribunal.

## **Judges of Fact**

Judges of Fact shall comprise of the following:

- a) A person or persons nominated by the Host Club conducting the competition;
- b) The Promoter appointed noise measurement officer; and
- c) The Host Club or Chief Scrutineer.

## **Junior Driver**

A Driver who holds a valid Junior Licence.

## **Junior Licence**

Licence issued to Drivers who must be over 5 years and under 17 years at the time of application.

## **Junior Mechanic**

A licence issued to a Junior aged 12 to 16 years at the time of application. For the purpose of conducting mechanical work in the pit environment.

## **Lap Sheets and Charts**

The official record of the positions of each Race Car on each lap of the Race taken at the Finish Line.

## **Log Book**

Issued as part of the Race Car registration process and is used to record information of the Race Car and any identified defects requiring corrective action.

**Licence**

A licence issued by Speedway Australia to a person to enable that person to take part in Events after the required fees have been paid.

**Licence Holder**

A person who holds a current Licence.

**Mandatory Appearance Offences**

Has the meaning ascribed to it under rule 7.7.2 of these rules.

**Marshal**

Any person with a speedway Marshals licence who is nominated to act in an official capacity at a Race Meeting.

**Medical/First Aid Personnel**

A person who is trained/accredited to provide first aid response at an event.

**Nomination**

An application made by a Driver to the organiser of a Race Meeting by which the Driver agrees to take part in a specific Event, usually involving the payment of a nomination fee.

**Participant**

Any person who participates in a Race Meeting in any capacity whatsoever including without limitation a Driver, Pit Crew Member, Race Car Owner, Marshal and Racing Official.

**Pit Crew Member**

Any person who is actively involved with a particular race car and team at a race meeting.

**Pit Marshal**

The person nominated and responsible for marshalling the pit area.

**Pits**

The restricted area of the Speedway Complex for the assembly of Race Cars and tow vehicles.

**Plea Bargain**

An agreement in which the Tribunal Chairperson and the defendant arrange to settle a charge of misconduct against the defendant for an agreed penalty, in exchange for a guilty plea.

**Pole Line**

Determined by cement kerb, gutter, line mark, or other distinct marking at inner edge of the Race Track and the commencement of the Infield.

### **Probation Period**

A probation period or good behaviour period is defined as a length of time set by a Chief Steward, Tribunal or Speedway Australia Head Office where a licence holder must not breach any Speedway Australia Racing Rule or Regulation within that period. If a rule breach during this period is identified by Speedway Australia an additional penalty will be applied to the licence holder.

### **Prohibited Substance**

Any drug or substance which has been deemed to be prohibited by Speedway Australia including, without limitation, the drugs and substances listed in rule 6.3.1.

### **Promoter**

The person or organisation promoting the Race Meeting or Event.

### **Race**

A competition between Race Cars in which the order of finishing is the factor determining the result.

### **Race Car**

A motor vehicle which complies with the class specifications of the controlling body for the particular Racing Division being raced at the Race Meeting.

### **Race Car Owner**

A person who has an ownership interest in a Race Car, either directly or through an entity such as a company or trust.

### **Racing Division**

A category for Race Car as determined by the class specifications.

### **Race Meeting**

A series of Events held at a Race Track which is deemed to begin two hours before the scheduled time of the first Event, or at the time scrutineering commences (whichever is earlier). It includes all programmed Events and is deemed to conclude thirty minutes after the finish of the last Event on the scheduled program or at a time after this as instructed by the Chief Steward or Promoter.

### **Race Secretary**

The person whose duties are set out in rule 5.9.

### **Race Track**

The designated area for speedway racing at the Speedway Complex between the Pole Line and safety fence.

### **Registration Decal**

Proof of the registration of a Race Car by an Affiliated Association or other controlling body approved of by Speedway Australia for this purpose which is issued when a Race Car is registered and must be attached to a prominent but protected location on the Race Car.

**Respondent**

Any party to a decision under these rules who is in opposition to the appeal of that decision. If the Appellant is a Competitor the respondent will be the person/body who is responsible for issuing the decision against which the Appellant is appealing.

**Rolling Start**

A Race start in which the participating Race Cars are rolling under their own power at a regulated speed towards the Starting Line.

**RSA**

Racing Sedans Australia Inc.

**Senior Licence**

A Licence in any Speedway Australia licence category except for a Junior Licence. The Licence Holder must be over 16 years of age.

**SCCA**

Sprintcar Control Council of Australia Inc.

**SSA**

Speedway Sedans Australia.

**SSAC**

Has the meaning ascribed to it under rule 3.3.2 of these rules.

**Scrutineer**

A person approved by Speedway Australia or an Affiliated Association to act as a scrutineer or technical officer and whose duties are set out in rule 5.5 of these rules.

**SKAA**

Speedway Kart Association of Australasia.

**Speedcar**

A Race Car which complies with the relevant technical specifications to be a Speedcar as set out by the relevant controlling body of that Racing Division.

**Speedway Appeal Tribunal**

The tribunal established under rule 8.2 of these rules.

**Speedway Australia**

NASR Incorporated.

**Speedway Complex**

The venue at which a Race Meeting is conducted, including the Race Track, Infield, Pits, public areas and car parks and any place where scrutineering for the Race Meeting is conducted.

**Sprintcar**

A Race Car which complies with the relevant technical specifications to be a Sprintcar as set out by the relevant controlling body of that Racing Division.

### **Starting Line**

As designated by the Chief Steward between turn four and the Finish Line.

### **Steward**

A Racing Official who has been designated as steward for the purpose of a Race Meeting and who has passed any necessary training.

### **Suspended Sentence**

A penalty which is suspended subject to satisfactory completion of a "good behaviour bond" for a specified period of time. If the conditions of the bond are breached, the relevant Tribunal or Speedway Australia Head Office may determine whether the full penalty must be served and, if the breach involves a further breach of the rules, the Tribunal or Speedway Australia Head Office may impose an additional sentence for that offence. If the bond is completed without further breach, the sentence is not required to be served.

### **Suspension**

A specific period of Disqualification given for a breach of these rules or the specifications, which may or may not include Disqualification and the suspension of the relevant person's Licence, applicable retrospectively.

### **Tribunals**

The Disciplinary Tribunal and the Speedway Appeal Tribunal.

### **Tribunal Chairperson**

The person appointed as the chairperson of the Disciplinary Tribunal or the Speedway Appeal Tribunal (as applicable).

### **Vintage Vehicle (V Class Licence)**

Any vehicle that **is 30 years or older, that** does not qualify to race & has been retired from racing at speedway tracks, complies with the relevant vintage vehicle member club specifications and is registered with that club.

### **Wingless Sprint**

A Race Car which complies with the relevant technical specifications to be a Wingless Sprint as set out by the relevant controlling body of that Racing Division.

## 1.1 COMPLIANCE AUTHORITY

- 1.1.1 Speedway Australia shall be the authority for the interpretation of, and compliance auditor for, these rules and regulations, referred to from here as 'these rules'. At any Race Meeting, this authority is delegated to the Chief Steward.
- 1.1.2 A Racing Rules Advisory Committee, consisting of representatives of National competitor groups, and the Speedway Australia National Council, has the responsibility for the review of these rules and the presentation of recommendations to the board of Speedway Australia for approval of changes.
- 1.1.3 It is the responsibility of each Participant to have a copy of and be familiar with, all relevant rules and regulations. By participating in a Speedway Australia sanctioned Race Meeting, each Participant is deemed to understand and to have agreed to comply with and be bound by these rules to the exclusion of all others, except where supplementary regulations approved for a specific Event pursuant to rule 1.4 may take precedence.

## 1.2 DISCLAIMER

- 1.2.1 These rules are designed to provide for the orderly conduct of Race Meetings, (including time trials and practice Events) and to establish minimum acceptable standards for such Race Meetings.
- 1.2.2 No expressed or implied warranty of safety shall result from any publication, enforcement or compliance with these rules, nor any variation or deviation of these rules pursuant to rule 1.3, nor any supplementary regulations approved pursuant to rule 1.4 and such enforcement and/or compliance is in no way a guarantee against injury or death to any Participant, be they a Driver, Pit Crew Member, Race Car Owner Marshal, Racing Official, or any other spectator or person whatsoever.
- 1.2.3 Neither Speedway Australia, any Affiliated Association, Club, Promoter, Marshal, Racing Official (acting in any capacity whatsoever), or any other Participant shall be liable to any prosecution or action for anything done pursuant to these rules, nor liable for any death, injury, loss or damage arising by any alleged failure to implement these rules at a Race Meeting.

### **1.3 VARIATION OR DEVIATION FROM THESE RULES**

- 1.3.1 At any Race Meeting, the Chief Steward shall be the only person empowered to permit or direct any reasonable variation from any of these rules, or to impose any further restrictions that in his or her opinion do not compromise safety nor alter the minimum acceptable standards as may be required in order to expedite the conduct of the Race Meeting. The Chief Steward must have regard to the guidelines for penalties provided in these rules or associated publications referred to in these rules (if any).
- 1.3.2 Neither Speedway Australia nor any Affiliated Association, Club, Promoter or Racing Official, using or varying these rules, shall be liable to prosecution or to any action for damages for breach of contract or to an injunction order or any judgement of a court at the instance of any Participant or any other person admitted to a Speedway Complex or for anything.

### **1.4 SUPPLEMENTARY REGULATIONS**

- 1.4.1 Supplementary rules and regulations, referred to from here as 'supplementary regulations', required for any Event not covered by these Rules (such as a long distance, championship, or feature Event) must be submitted by the Promoter of the Event to the State Executive of the relevant Affiliated Association at least 30 days prior to the Event to allow time for approval and publication on the nomination or entry forms.
- 1.4.2 Supplementary regulations may cover such items as pit stops and Infield refuelling and must demonstrate the manner in which existing safety provisions will not be compromised.
- 1.4.3 The State Executive or National Executive of the relevant Affiliated Association has the right to approve or reject all or part of the supplementary regulations included in the submission and may stipulate added safety precautions.
- 1.4.4 The submission must list the date(s) of the Event, the name of the Event and the promotional body who will be responsible. It must also list the supplementary regulations, why they are required and demonstrate the benefit(s) of such supplementary regulations.
- 1.4.5 Following the relevant State Executive approval, the details of any supplementary regulations must be included with any nomination or entry forms for the special Event and must be reiterated at the Drivers' Briefing.

- 1.4.6 If the supplementary regulations are endorsed by the State Executive, approval will be forwarded within 14 days of the application, clearly stating the date(s) of the Event, the name of the Event and a full list the supplementary regulations and an approval number for the Event.
- 1.4.7 In the event of extraordinary circumstances (such as a rainout or postponement) the State Executive reserves the right to alter the supplementary regulations in writing and distribute them to all Participants.

## **1.5 SUPERSEDED RULES**

- 1.5.1 Adoption of these rules shall take precedence over any and all pre-existing rules that pertained to speedway racing previously conducted or regulated by Speedway Australia or other governing or regulatory body in Australia.
- 1.5.2 Such precedence shall not affect or change:
- a) The previous operation or interpretation of any rule so annulled or superseded; or
  - b) Any right, privilege, obligation or liability acquired, accrued or incurred pursuant to any rule so annulled or superseded; or
  - c) Any penalty or Disqualification previously incurred in respect of any offence committed against any rule so annulled or superseded.

## **2.1. NOMINATIONS**

- 2.1.1. The Promoter, Speedway Australia or other relevant organising bodies has the right to refuse any Nomination.
- 2.1.2. A Driver cannot nominate more than one Race Car for the same Racing Division at the same Race Meeting or nominate for two separate Race Meetings scheduled for the same date. A Driver may however practice in more than one Race Car at the same Race Meeting or compete in another Race Car in another Racing Division.
- a) For all events/race meetings, nominations/late nominations will be deemed to have closed at the conclusion of scrutineering. Applicable to driver or car.
- Formula 500 – Refer Appendix 5, 2.1**
- 2.1.3. Any driver proven to have nominated for two separate race meetings scheduled for the same date, as per Rule 2.1.2, shall be liable for a fine of up to \$500. The fine is to be issued by the Steward in control of the “non-attended” race meeting, within seven days, as per Rule 7.1.2.
- 2.1.4. At Race Tracks where Drivers are required to nominate, any Driver who is a late nomination or arrives at a Race Meeting with the intention of competing without nominating may be subject to a late nomination fee. The Driver may also be required to start at rear of field during any heat Races. For qualification into any Main/Final/Feature event, the nominated driver must have competed in at least one (1) qualifying event.

### **SSA - Refer Appendix 3, 2.1**

## **2.2. LICENCES**

- 2.2.1 All Drivers participating in any Event must be in possession of a current Licence in the relevant Racing Division and hold an Infringement Card (where applicable) that is free of unpaid fines and/or current Suspensions. **Only drivers who are licensed for a Racing Division are permitted to drive the respective race cars during a Race Meeting, inclusive of scrutineering.** All Racing Officials and Marshals participating in any Race Meeting must also be in possession of a current Licence.
- 2.2.2 **If a person competes in a Race Meeting and subsequent to that Race Meeting it is confirmed that the person did not at the time of the Race Meeting have a Licence to drive in the Racing Division in which**

the person raced they shall be disqualified from that Race Meeting, suspended for six months and fined \$1000. For licensees with a current Speedway Australia licence, the suspension period will begin from date of the infringement. For individuals with no current Speedway Australia licence, the suspension period will begin from the date of licence renewal.

- a) If a person officiates at a Race Meeting as a Racing Official and subsequent to that Race Meeting it is confirmed that the person did not at the time of the Race Meeting have a Licence or was not accredited as a Racing Official, they shall be fined \$500.
  - b) If a person submits a fraudulent medical form, they will be unable to obtain a Speedway Australia licence for 12 months.
  - c) Speedway Australia provides Licence categories ranging from Sprintcar Drivers (AA Licence) to Junior Mechanics (JM Licence). The definition of these categories is available from the web site ([www.speedwayaustralia.org](http://www.speedwayaustralia.org)) under "Licencing", and then "Licence Categories".
  - d) An Infringement Card (where applicable) must be appended to each Driver's Licence and may include one day licences. Upon service of an Infringement Notice, the Chief Steward must fill in the Driver's Infringement Card. (relevant for categories with infringement cards).
- 2.2.3. Junior Licences are issued to Drivers from:
- i) 5 years of age for JDJQMA licence holders
  - ii) 6 years of age for Outlaw Karts
  - iii) 7 years of age for SKAA Juniors & Derby Sliders
  - iv) 10 years of age for Junior Sedans & F125 Juniors
  - v) 12 years of age for Junior Formula 500's
- (a) All juniors must be under 17 years of age, at the time of applying for their licence, subject to State Government requirements.
  - (b) All junior competition licences expire on the day prior to the competitors 17<sup>th</sup> birthday.
- 2.2.4. Only persons 16 years or older may apply for a Senior Licence.
- 2.2.5. Once a Junior Driver has graduated to a Senior Licence category and races with a Senior Licence that Driver is ineligible for further competition as a Junior Driver.
- 2.2.6. Junior Drivers are not permitted to compete against Senior Drivers.
- a) A junior licence holder is permitted to practice in a senior division competition vehicle, providing they are at least 16 years of age and hold the correct one-day practice licence for that division. The safety attire worn must also meet the relevant Speedway Australia rule requirements for that division.
- 2.2.7. A Junior Licence holder is required to have a parent or guardian, who holds an Annual Speedway Australia Licence, with them whilst at a Race Meeting.

These licences will be offered as a “non-competitive” licence.

- a) No Junior Competitor will receive prize money from competing in a junior event.
  - b) Parents/Guardians need to sign a release form allowing for photos/videos to be taken of their children while competing under a Junior Licence.
- 2.2.8. Licences and Infringement Cards must be available for inspection by the Chief Steward, Scrutineer, Race Secretary or other authorised Marshal.
- 2.2.9. Any Driver receiving payments under any workers compensation scheme or benefits from any accident insurance policy is only permitted to compete if a recognised medical practitioner has provided a medical clearance.
- 2.2.10. Drivers receiving medical treatment shall produce a medical certificate stating that they are medically fit to compete before a Licence will be issued in accordance with Speedway Australia's Licensing Policy.
- 2.2.11. Whether through an accident, or for any other reason, a Driver is considered unfit to continue racing, the Chief Steward, after consulting with ambulance or paramedic personnel, may order that the Driver not compete for the remainder of the Race Meeting and the Driver shall not be allowed to compete for the remainder of the Race Meeting. Drivers receiving medical treatment shall produce a medical certificate stating that they are medically fit before being permitted to compete in any Event.
- a) Any driver involved in an accident that the Chief Steward deems serious, will be subjected to a health check by ambulance/first aid personnel. This will be at the discretion of the Chief Steward and the driver involved will not compete further at the race meeting until such time as the health check is carried out.
  - b)(i) When a competitor is diagnosed with concussion by a Doctor or Medical Officer the stand-down period from racing is a minimum of 12 days, commencing from the date of the injury.
  - (ii) Where a Racing Official, Marshal or member of the track medical team has reason to believe that concussion or unconsciousness has occurred, the stand-down period from racing is a minimum of 12 days, commencing from the date of the injury.
  - (iii) In either case above a written medical clearance on the approved form is required prior to the resumption of racing. This is to be obtained from a recognised concussion clinic or the doctor who completed the competitor's most recent medical examination, as per their licence application.
  - (iv) A competitor diagnosed with concussion can apply to the Speedway Australia Office to have their stand-down period reduced. They will be required to provide detailed information (on the approved form) from a recognised concussion clinic or from the

doctor who completed their most recent medical examination, as per their licence application.

- (v) The stand-down period referred to in clauses (i) and (ii) is to be confirmed by the Steward of the Race Meeting issuing an Infringement Notice.
- 2.2.12. A Driver participating in any Event must have the following items at the Race Track to be allowed to participate:
- a) A current Speedway Australia Licence and an Infringement Card (if required by relevant division);
  - b) A current registered Race Car;
  - c) A current Log Book for that Race Car;
  - d) Safety apparel complying with the relevant Racing Division specifications;
  - e) Access to a current Australian Speedway Racing Rulebook download; and
  - f) A current class specification book or download.
- 2.2.13. A passenger (as approved in some classes) must also have items (a), (d), and (e).
- 2.2.14. In the event of items (c) or (e) being unavailable at the Race Meeting, due to extenuating circumstances only, a temporary issue form for those items must be completed before being allowed to compete. These forms are available from the Race Secretary or Pit Marshall and must be forwarded to the secretary of the relevant Affiliated Association or other controlling body with the nominated fee.

#### **Sprintcars – Appendix 1, 2.2**

#### **SKAA - Refer Appendix 4, 2.2**

#### **2.2.15. Log Books**

Log Books are issued to Racing Officials when they receive their Licences. These log books should be used to record training courses attended and also record Race Meetings where the Racing Official participated.

#### **2.2.16. A One Day Licence** will only be available for open competition for Junior, SSA, B, E, V, SKAA and A and AA Class Sedans licenced Racing Divisions.

- a) One Day Licences are not available for 'AA' or any other 'A' class licence not listed above.
  - b) One Day Licences are available for non-racing activity for all Racing Divisions (i.e. Mechanic's Days, Practice Days, Promotional/Sponsor Days).
  - c) Only two One Day Licences can be purchased per Competitor per season for competition purposes. After the 2 Licences have been used the Competitor needs to upgrade to a full licence.
  - d) One Day Licences are issued by Speedway Australia's national office. The details of the Speedway Australia One Day Licence Policy are available from our website under "Licensing".
- 2.2.17. Speedway Australia may at its sole discretion, refuse to issue or may revoke or suspend a Licence to an applicant including, without limitation, if the applicant:

- a) Does not comply with any of the rules, regulations or policies issued by Speedway Australia; or
- b) Does not properly or accurately complete an application for a Licence or does not meet all the requirements stated in the application.

### **2.3. NEW DRIVERS**

- 2.3.1. New Licences will only be issued to Drivers that have passed the Speedway Australia medical examination and any theoretical Driver's examination as required by Speedway Australia's or the relevant association's Licensing Policies.
- 2.3.2. Drivers competing in their first Race Meeting will be required to start rear of field and continue to do so until the Chief Steward clears them to start in the field.
- 2.3.3. Chief Stewards are required to view a Driver's Licence and endorse the Infringement Card, if applicable, before the Driver can start in the field.
- 2.3.4. Upon receipt of a One Day Licence a prospective new Driver may practice with licensed Drivers at official practice sessions.

### **2.4. JUNIOR RACING**

- 2.4.1. Clubs, Associations, Promoters and Speedway Venues cannot allow any Junior Events (practice or racing) to commence after 11.00pm.
- 2.4.2. Junior Drivers are permitted to "track pack" as part of a Grand Parade at the same time as a senior licence holder but must not hot lap or engage in competition at the same time as a senior licence holder.

***Please refer to Rules 2.2.5 through 2.2.8 for specific details relating to Junior Licence Holders.***

## 3.1. RACE CAR REGISTRATIONS AND LOG BOOKS

- 3.1.1. All Race Cars competing in Speedway Australia sanctioned Race Meetings or Events must be registered by an Affiliated Association or other controlling body approved by Speedway Australia for this purpose.
- 3.1.2. Upon registration, a Log Book must be issued for each Race Car. The Log Book must remain with that Race Car for the racing season. Upon sale of a Race Car the Log Book will transfer with the Race Car to the new Race Car Owner. Log Books are not transferable between Race Cars.
- 3.1.3. A lost Log Book can be replaced by presenting an application form, with the appropriate fee where required, to the secretary of the Affiliated Association or other controlling body which issued the original Log Book.
- 3.1.4. Before competition, registered Race Cars must have a Registration Decal affixed in a prominent but protected location on the Race Car, such decal clearly showing the period of validity of the registration.

### **SKAA - Refer Appendix 4, 3.1.1 through to 3.1.4**

- 3.1.5. All entries in Log Books for repairs must be completed prior to the next Race Meeting unless otherwise stated.
- 3.1.6. Log Books will be checked at scrutineering for validity and outstanding work orders. If the Log Book is presented with work orders outstanding, the Driver will be given the option of fixing the faults. If the Driver opts not to fix the faults, the Race Car concerned will not be cleared to race. The Log Book will be retained by a Racing Official and forwarded to the secretary of the Affiliated Association or other controlling body which issued the Log Book.

## 3.2. RACE CAR COMPLIANCE

- 3.2.1. All Race Cars shall comply with the specification requirements of the relevant Affiliated Association or other controlling body. These bodies shall be the sole authority for Race Car compliance, and also should provide recommendations on actions or penalties in relation to Race Car non-compliance to the Chief Steward. The Chief Steward must have regard to the guidelines for penalties provided in these rules or

associated publications referred to in these rules (if any) when imposing penalties for non-compliance.

- 3.2.2. Prior to the commencement of each racing season and at any other time that the relevant Affiliated Association or other controlling body may direct, the Race Car Owner of every Race Car shall submit his Race Car and safety equipment for inspection at a time to be decided by the relevant Affiliated Association or other controlling body.

**SSA – also Refer Appendix 3**

**3.3. PROTECTIVE CLOTHING AND SAFETY EQUIPMENT**

- 3.3.1. Drivers participating in any Event at a Race Meeting or official practice, must wear all approved safety equipment and protective clothing complying with the Speedway Australia minimum standards for safety apparel for the relevant Racing Division. **If any driver is found to not be wearing all approved and compliant safety equipment and protective clothing following an event, they will be disqualified from that event and fined \$500 for their first offence. For a subsequent offence in the following 12-month period, they will be disqualified from the event, fined \$1000 and have their licence suspended for 3-months.**

Any other person entering the Race Track or Infield must, at all times while on the Race Track or Infield, wear high visibility clothing where applicable, or other specified safety apparel. These requirements may be relaxed for grand parades and Driver presentations, as may be authorised during the Drivers' Briefing or by the Chief Steward.

- 3.3.2. Speedway Australia has established a Speedway Safety Advisory Committee (**SSAC**) which researches, investigates and provides recommendations on speedway related safety matters. The SSAC has developed safety apparel standards for speedway Drivers, which have been approved by the board of Speedway Australia. The minimum standards for safety apparel for the various racing Divisions are presented in Sections 14 – 17 – Minimum Speedway Safety Standard for Apparel.
- 3.3.3. At any Race Meeting or Event, the minimum requirements are (for practice sessions for Sprintcars & Wingless Sprints, Refer to Rule 3.3.10):
- a) Regular Race Meeting standard quantity of fire extinguishers and fire crew
  - b) Race Meetings and official practice sessions require:
    - i. A minimum of two first aid personnel (paramedics, ambulance service, doctor or qualified first aid personnel);
    - ii. A station wagon capable of transporting minor injury cases; and

- iii. An appointed person equipped with an operative mobile phone and supplied with the phone number of the nearest road transport ambulance service.
- 3.3.4 An approved State Service road going ambulance or equivalent service provider must be present at all Sprintcar Race Meetings and is highly desirable at all other Race Meetings. Please reference the SCCA Rulebook for their specific requirements for Sprintcar & Wingless Sprint racing.
- 3.3.5 The local ambulance service must be notified of the holding of a Race Meeting or practice on that day.
- 3.3.6 A designated person (e.g. Chief Steward) is to be clearly in control of all activities on the day.
- 3.3.7 All Participants, including Racing Officials, Marshals and Pit Crew Members are to sign a "Release and Waiver of Liability / Assumption of Risk and Indemnity Agreement" form prior to entering the Pits.
- 3.3.8 All Participants must understand that in accordance with their duty of care, the choice is clearly theirs if they decide to participate under the conditions that exist at the time.
- 3.3.9 For any private practice or training session not covered under Rule 3.3.3 and 3.3.10, the minimum safety requirements are two persons other than the Driver, a suitable fire-extinguisher with the use of which they are familiar, an industrially acceptable first aid kit and a serviceable telephone.
- 3.3.10 For all Sprintcar Drivers, minimum safety requirements for practice are:
  - a) Normal approved quantity of fire extinguishers and fire crew.
  - b) A minimum of two first aiders i.e Paramedics, St John or qualified first aid personnel;
  - c) Station wagon capable of transporting minor injury cases;
  - d) Appointed person equipped with an operative mobile phone and supplied with the phone number of the nearest road transport ambulance service;
  - e) Local ambulance services to be notified of the holding of a practice on that day;
  - f) A designated person approved by the State Member Club, e.g. a Steward to be clearly in control of all activities on the day;
  - g) It is recommended that only one (1) Sprintcar to be on the Race Track at any one time;
  - h) All Drivers and crews to sign an Insurer's Sprintcar Practice Waiver/Indemnity form and to be clearly informed the emergency provisions may not be to the standards of Race Meetings; and
  - i) All Participants must understand that the choice is clearly theirs if they decide to participate under the conditions that exist at the time.
- 3.3.11 Medical/First Aid personnel must be exclusively appointed to that role throughout the course of the event.

- 3.3.12 At any time, all Drivers, Race Car Owners and Pit Crew Members will dress in a clean and tidy manner. Open footwear is not permitted in the Pit during a Race Meeting.
- 3.3.13 In accordance with the Speedway Australia Track Operators Manual a set of pit rules have been implemented for use during sanctioned Race Meetings. These rules are provided in Section 3.7.

#### **3.4. MIRRORS AND COMMUNICATION EQUIPMENT**

- 3.4.1. No rear or side view mirrors or highly polished panels intended for this purpose are permitted on any Race Car.  
**Exceptions: RSA Fender Benders Division 1 & 2 and QLD Stockcars.**
- 3.4.2. One-way in-car communications is permitted only from the Chief Steward (or his delegated Racing Official) to the Driver.
- 3.4.3. **The use of one-way in-car communications is compulsory for all Speedway divisions.**
- 3.4.4. No additional communication equipment, including mobile phones, smart watches, Bluetooth devices or any other remote communication device is permitted to any Driver in a Race Car on the Race Track. A minimum penalty of 12 months suspension will apply to any Driver and Race Car Owner (where the Driver is not the Race Car Owner) if found guilty of using an unauthorised communication device.
- 3.4.5. In car cameras must be securely mounted and may only be used as evidence for a tribunal/appeal if accepted by the Chief Steward or tribunal. Any in car camera can only be mounted on a helmet if the helmet manufacturer guidelines allow it.

#### **3.5. NOISE CONTROL**

- 3.5.1. The maximum level of noise that may be emitted by a Race Car is 95 dB (decibels).
- 3.5.2. The measurement and monitoring of noise levels is the sole responsibility of the Promoter of the Race Meeting and shall be conducted according to the latest Local, State or Federal Government guidelines, as applicable. Race Officials shall give full support to noise control monitoring procedures undertaken by the Promoter.
- 3.5.3. A Race Car may be disqualified from a Race for exceeding maximum permissible noise levels, but will always initially receive a noise flag warning. If they continue to exceed the noise level requirements a black flag will be shown. Failure to obey the black flag will result in a penalty in accordance with rule 4.17.2.  
**SSA, RSA and AMCA - Refer Appendix 3, 3.6**

### 3.6. MINIMUM VENUE FIRE SAFETY STANDARDS

The following fire safety standards are the minimum requirements for speedway venues at race meetings.

#### 3.6.1 Manned Quick Response Vehicle

One quick response vehicle manned with 2 fire marshals & parked on the infield with the following:

- a) 6x ABE 9kg Powder Fire Extinguishers
- b) 4x ATC Foam/Cold Fire (or equivalent) 9 Litre extinguisher
- c) 1x 9 Litre Water Fire Extinguisher
- d) 1x Jaws of Life Combination Tool (if possible)

#### 3.6.2 Infield Fire Marshals

Two fire marshals at either end of the infield with:

- a) 1x ABE Powder Fire Extinguisher
- b) 1x ATC Foam/Cold Fire (or equivalent) 9 Litre extinguisher

#### 3.6.3 Pit Fire Marshal

One fire marshal in the pits (manning the pit return road) with:

- a) 1x ABE Powder Fire Extinguisher
- b) 1x ATC Foam/Cold Fire (or equivalent) 9 Litre extinguisher

#### 3.6.4 Protective Clothing

It is recommended all fire marshals should be in full protective clothing i.e. ISO Fire Suits or FIA/SFI-rated race Overalls/gloves/balaclavas, lace up leather footwear with an AS/NZS safety rating, along with protective eye and ear protection.

#### 3.6.5 Dedicated Fire Marshals

Fire Marshals must be exclusively appointed to that role throughout the course of the event.

### 3.7 PIT HEALTH AND SAFETY

The following are the rules which should apply to the Pits and Race Track area. Any breach of these rules by a Speedway Australia licence holder may result in exclusion of the licence holder from restricted area including the infield and Pits and may also result in further action from Racing Officials.

#### 3.7.1 Alcohol & Drugs

- a) There is to be no drinking of alcohol in the Pits during a Race Meeting and glass containers of any kind must not be used at any time in the Pits.
- b) No intoxicated persons or persons under the influence of drugs are allowed in the Pits or Race Track area.
- c) Smoking is not permitted in the Pits or Race Track area with the exception of designated areas.

#### 3.7.2 Dress Code

**Minimum dress requirements are shorts, short sleeved shirt (no singlets) or t-shirt and fully Enclosed Shoes. Shoes with large perforations and straps in the uppers (such as "croc" style shoes) and sandals are not permitted.**

- 3.7.3 **Axle stands** must be used at all times if a person is working under a Race Car.
- 3.7.4 Any **fuel** brought into the Pits must be stored in an approved container.
- 3.7.5 **Vehicle Speed:** Cars (including Race Cars) in the Pits must be driven at a speed not exceeding a reasonable walking pace at all times.
- 3.7.6 **Quad Bikes**
- a) Quad bikes must only ever be ridden at a speed not exceeding a brisk walking pace within the Speedway Complex.
- NOTE:** For SKAA Speedway Karts, 3.7.6(a) does not apply when push starting from the pits. Instead a clearly defined hot area (rope barriers etc), set as the shortest practical distance from pit to track i.e. directly in front of chute/track entry gate. The Marshal in charge of the pit gate is to ensure that the area is completely clear before giving the call to start a race.
- b) A person riding a quad bike or any vehicle with handlebars (regardless of vehicle having a roll cage), must wear a helmet complying with AS1698 as minimum standard (may be open face helmet). Drivers of all other vehicles must wear a seatbelt, however if there is no seatbelt present, a helmet must be worn.
- c) Quad bike riders must hold an Adult Speedway Australia Mechanics, Marshals or Competition Licence.
- d) Passengers: No riding on Race Cars or additional people on quads; only riders permitted on quads.
- 3.7.7 **Children in the Pits**  
Children under the age of 16 years are not permitted in the Pits unless they are:
- a) Children aged 12 to 15 years who possess a Speedway Australia competition, junior mechanic or junior marshals licence.
- b) Children aged 5-11 years who possess a Speedway Australia competition licence and are actively competing in the race meeting.
- 3.7.8 Children in the pits are required to be under the direct supervision of a parent or guardian, who holds an annual Speedway Australia licence with them whilst at a race meeting.
- 3.7.9 **Push starts**
- a) No push starting of Sprintcars, Wingless Sprints, Speedcars or any class of Race Car with or without a clutch in any part of the Pits.
- b) Drivers must have permission from Pit Marshall or Race Director for push starts on Race Track prior to and during Race Meetings.
- 3.7.10 **Arrival of safety equipment**  
Minimum standards for fire and first aid response must be in place before engine starts.
- 3.7.11 **Scrutineering**  
All Race Cars must be scrutineered prior to practice or racing.

### 3.7.12 **Safety Gear**

Full racing safety gear must be worn for all engine starts, practice and racing including helmets, clothing, gloves, neck collar and all belts must be tightened.

### 3.7.13 **Chain of Command**

- a) Drivers and Pit Crew Members must follow directions of Racing Officials, Marshals and fire and ambulance personnel at all times.
- b) Any person having problems in the Pits should bring them to the attention of the Pit Marshall immediately.

### 3.7.14 **Injuries**

Any person who has been injured at Race Meeting must report the incident to the Race Secretary on the day of the Race Meeting.

3.7.15 **Abusive behaviour or misconduct** is not to be tolerated and any incident must be reported to the Chief Steward immediately.

### 3.7.16 **Withdrawals**

Cars that have withdrawn from racing should advise the Pit Marshall as soon as possible.

### 3.7.17 **Fire Extinguishers**

All speedway teams (except SKAA Karts) are required to carry as a minimum in the pit area/transporters:





- a) A 2.0kg Dry Chemical Powder Extinguisher OR GREATER. It must strictly be used with the following compliance points:
- b) The fire extinguisher is compliant with AS (Australian Standard) 1841.5 and carries the Australian Standards Tick Certification sticker on the body of the extinguisher. AS1841.5 pertains to (powder extinguishers) design and commissioning standard.
- c) The standard AS/NZS1841.1 also is stamped on the bottom or rim of the Extinguisher under the powder coat or paint. AS/NZS1841.1 pertains to (General Requirements) for Design, and Commissioning Standard.
- d) The extinguisher must carry a yellow date tag in accordance to AS1851 section 15.
- e) Other types of fire extinguishers that will comply to this ruling are:
  - 9 Litre AFFF Foam extinguishers, AR or ATC type.
  - 9 Litre Cold Fire extinguishers.





All of the above information was taken from AS1851-2005 (maintenance of fire protection systems and equipment) Australian Standard Professional Pack.

- f) **Speedway teams (except SKAA Karts) who do not comply with 3.7.17 a – e will not be permitted to take part in the Race Meeting until the Chief Scrutineer has sighted a compliant fire extinguisher and notified the Chief Steward.**

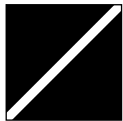
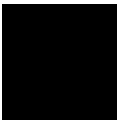
## 4.1 FLAG, LIGHT AND BOARD SIGNALS

- 4.1.1. All flags shall be a minimum of 600mm x 600mm. Stripes on flags shall be 80mm wide and spots shall be 300mm in diameter.-
- 4.1.2. All Race Meetings conducted at night must have serviceable green, yellow and red lights. These lights shall be used in addition to green, yellow and red flags.
- 4.1.3. The following light and flag signals will be used for all Racing Divisions:

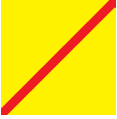
	<p><b>GREEN LIGHT and FLAG</b> Start, or restart of Event, or Event is in progress</p>
	<p><b>YELLOW LIGHT and FLAG</b> Caution - hold position at reduced safe speed</p>
	<p><b>CROSSED YELLOW and GREEN FLAGS</b> Field to form up for a start or a complete restart</p>
	<p><b>RED LIGHT and FLAG</b> Stop immediately and do not go past accident scene or cut across Infield - while exercising due caution</p>
	<p><b>BLACK FLAG with WHITE DIAGONAL STRIPE</b> Warning - due to rule infringement. Driver is subject to enquiry from Chief Steward and may be penalised for infringement(s)</p>
	<p><b>BLACK FLAG</b> Disqualification - Driver to withdraw from Event using caution whilst doing so</p>

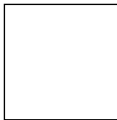
	<p><b>BLACK FLAG with WHITE SPOT</b>  Mechanical defect - Driver to retire to infield, using utmost caution</p>
	<p><b>YELLOW FLAG with BLACK DIAGONAL STRIPE</b>  Noise flag - Driver may continue to race, but if noise level remains high, black flag will result</p>
	<p><b>YELLOW FLAG with RED DIAGONAL STRIPE</b>  Fire Flag – Drivers to withdraw from the race immediately in the safest practical manner.</p>
	<p><b>BLUE FLAG with YELLOW SPOT</b>  Lapping flag – Race Car is soon to be lapped. Lapped Race Car to hold line and not impede lapping traffic</p>
	<p><b>WHITE FLAG (or light)</b>  One lap to go</p>
	<p><b>BLACK AND WHITE CHEQUERED FLAG</b>  Finish of Event - reduce speed gradually</p>

4.1.4. Where any confusion is possible as for which Race Car a flag signal is intended, the flag should be shown in conjunction with a board showing the Race Car number and where possible through the use of one-way communications.

4.1.5. In conjunction with flag signals, the following signboard signals may be shown:

- REAR OF FIELD or ROF - together with a Race Car number to avoid confusion;
- COMPLETE RESTART - for a restart in accordance with rule 4.12;
- SINGLE FILE RESTART or RESTART - for a restart in accordance with rule 4.13.

## 4.2. DIRECTION OF RACING

The direction of racing is anticlockwise for the majority of Racing Divisions, however where applicable, the direction of racing will be determined by the supplementary regulations for the relevant Racing Division.

## 4.3. DUMMY GRID LINE UP

4.3.1. Race Cars should take up their correct position on the dummy grid ready to race before entering the Race Track. The Pit Marshall will close up any spaces left by any scratching by moving Race Cars forward in their rows.

**SSA – Refer Appendix 3, 4.3.1**

**Formula 500 - Refer Appendix 5, 4.3.1**

4.3.2. Any Driver whose Race Car is not positioned on the dummy grid and has notified the Pit Marshall, may be given two minutes to have their Race Car ready at the gate to go on to the Race Track. The two minute time commences when all the Race Cars in the Race are on the Race Track and moving.

**SKAA – Refer Appendix 4, 4.3.2**

4.3.3. No work or adjustment can be carried out on a Race Car while it is on the dummy grid. Any Race Car requiring any work or adjustment must be taken from the dummy grid and returned to the Pits. The driver may be disqualified from that event if not adhered to.

4.3.4. Once the Race Cars are on the Race Track, prior to the start of a Race and there is a withdrawal then the Race Cars move straight forward to fill the gap.

## 4.4. PUSH STARTS

4.4.1. **Each Race Car is allowed unlimited push starts without penalty before the initial Race start** and a push restart following any red light/flag stoppage where the incident did not involve that Race Car, and the car stopped due to the red light, or the Race Car was an innocent party in the stoppage.

**Sprintcars - Refer Appendix 1, 4.4**

**Speedcars - Refer Appendix 2 4.4**

4.4.2. For all Race Cars, when a Race Car is receiving a push start, if that Race Car does not start within one lap then the Race Car must be shown the mechanical defect flag and directed onto the infield.

## 4.5. RACE STARTS

4.5.1. Drivers are responsible for knowing their grid positions and maintaining these positions until the green light/flag. Any Race Car that delays the start of a Race by more than two minutes will go rear of field. Any Race Car still not ready by the time the green is shown will be excluded from the Race.

SSA – Refer Appendix 3, 4.5.1

- 4.5.2. If a Race is to be gridded up using a pace car, once the pace car is established on the Race Track, no Race Car may pass the pace car (either on the Race Track or by running across the Infield) for the purpose of chasing and joining the field. Offending Drivers will be subject to a \$100 fine. The correct method is to slow down and allow the field to catch up, and then merge into position.
- 4.5.3. When the field is formed up and a start is imminent, the yellow lights and flags will be switched off and withdrawn, during the first half of the final roll-up lap.
- 4.5.4. The Starting Line may be represented by a white line placed across the circuit at a location to be determined by the Chief Steward between turn 4 and the Start/Finish Line.
- 4.5.5. The Race Car starting from position one will be the pole Race Car.
- 4.5.6. The Race Cars on the front row will maintain a moderate speed as they approach the acceleration zone, or as directed by the Chief Steward. The acceleration zone is defined as the zone between the exit of turn four (which may be marked by a white line or cones) and the Start/Finish Line. As the Race Cars on the front row reaches the acceleration zone, or somewhere within this zone, the green light/flag will be shown.
- 4.5.7. A start will not be aborted, but if the Chief Steward declares a 'no start', the yellow light/flag signal will be given after about half a lap, and the field will be required to carefully slow down and grid up again.
- 4.5.8. Where time trials are used to determine starting positions in heat Races any Race Car that is unable to do a lap in time trials will automatically start rear of field in the heat Races for that Race Meeting.
- 4.5.9. Any Driver not taking their time trial in the correct time trial order has the option of completing one lap at the end of the time trial, however, they cannot do any better than one position less than 50% of the field or group.

#### **4.6. STARTING OPTION**

- 4.6.1. In Race formats where the highest point scorer starts the feature Race on pole, the highest point scoring Driver will be given the option of starting in either the inside or outside position of the front row, unless indicated by a supplementary regulation or rule. The highest point scoring Driver must make their decision when advised to form up for a race start by the Chief Steward.
- 4.6.2. The highest point scoring Driver must make their decision, as per Rule 4.6.1, when advised to form up for a race start by the Chief Steward. There will be no change to any other starting positions.

**Sprintcars – Refer Appendix 1, 4.6**

## **4.7. BREAKING FORMATION OR JUMPING THE START**

- 4.7.1. All Drivers must hold their correct positions and not accelerate until the green light/flag is shown. Any Race Car **on the front row**, including the pole Race Car, that breaks formation or jumps the start will be shown the warning flag or advised per their race receiver for the first offence and will go rear of field for the second offence. A car that baulks or slows down will also be considered to have broken the start.
- 4.7.2. If a Race Car breaks formation or jumps the start from within the field, but the Chief Steward wishes the Race to continue, the warning flag will be shown to the offending Driver and the Driver may be penalised. If the jumped start enabled Race Cars to be passed unfairly, the Driver will be put back two positions for each Race Car so passed. This penalty will be applied at the next stoppage, or if no stoppage, will be applied in the results.

## **4.8. RECKLESS OR DANGEROUS DRIVING**

- 4.8.1. Except for specific Racing Divisions (fender benders, etc.), speedway racing is a non-contact sport.
- 4.8.2. No Driver shall ever allow their Race Car to make deliberate, reckless or negligent contact with any other Race Car or be driven dangerously either in roll-up laps, during the Event, after the Event or in the Pits that may endanger others.
- 4.8.3. Unless directed by a Racing Official, any Driver who drives his or her Race Car at speed on the Infield will be considered to be driving dangerously.
- 4.8.4. Any Driver driving contrary to rules 4.8.1 and 4.8.3 will be excluded from the Race. For serious offences the Driver could also be subject to an Infringement Notice. As it is not possible to be certain whether contact between Race Cars has been deliberate, and so that it cannot be argued in a Driver's defence at a dispute hearing or a subsequent appeal, an Infringement Notice relating to reckless or negligent driving will not use the word 'deliberate'.
- 4.8.5. Any driver who accelerates their vehicle in a manner that instigates a break in traction, whilst the race is under caution (Yellow Flag/Light) may be penalised as per Rule 4.8.3. The Chief Steward and/or Clerk of Course/Race Director are the sole authority to allow permission to be in breach of this Rule.

## 4.9. PASSING

- 4.9.1. Any Driver who intends to overtake (pass) another Race Car, must first be reasonably sure that the passing move is possible without making contact with the other Race Car and then must execute the move as cleanly as possible.
- 4.9.2. Any Driver who becomes aware that another Race Car is making a passing move must not change line so as to inconvenience the passing Race Car, nor deprive that Race Car of adequate space on the Race Track. However, unless the Race Car being passed is a lapped car, there is no obligation for this Race Car to facilitate the passing move, the only obligation being not to change line in such a way that is intended to impede or to make the passing move more difficult.
- 4.9.3. If the Chief Steward believes that any passing move has been made contrary to rules 4.9.1 or 4.9.2, the offending Driver will be subject to a warning flag. This applies to both a Driver trying to pass and a Driver trying to impede the pass. Any Driver who makes gains by careless passing will be penalised two positions for each Race Car passed. This penalty will be applied at the next Race stoppage, or if no stoppage, will be applied in the results of the Race.
- 4.9.4. No Driver shall put any wheel on the Infield (below the Pole Line) when racing and in particular when attempting a passing move. Any Driver who uses the Infield to pass another Race Car will be put back two positions for each Race Car passed. This penalty will be applied at the next Race stoppage, or if no stoppage, will be applied in the results of the Race.
- Sprintcars – Refer Appendix 1, 4.9.4**
- 4.9.5. If a Driver persistently breaches rule 4.9.1, 4.9.2 or 4.9.4, a rear of field penalty will be applied at the next Race stoppage, or if no stoppage, applied in the results of the Race. At the Chief Steward's discretion an offending Driver may be disqualified and/or issued an Infringement Notice for reckless or dangerous driving as per Rule 4.8.3.

## 4.10. RACE TRACK RE-ENTRY

- 4.10.1. Any Driver who loses control to the Infield or who otherwise leaves the Race Track for any reason and wishes to re-join the Race may do so only with the utmost care and consideration for the safety of other Drivers. To avoid conflict, Race Cars must re-enter the Race Track at the most acute angle possible and re-entry on corners should be avoided.
- 4.10.2. If the Chief Steward believes that any Race Track re-entry has been careless or reckless, the Driver will be subject to a warning flag, a rear of field penalty or Disqualification and/or a fine, depending on the severity of the offence.

## 4.11. RACE INCIDENTS AND STOPPAGES

- 4.11.1. Following a crash or incident for which the Chief Steward orders yellow caution lights and flags, all Race Cars not directly involved in the incident must slow down to a safe speed and hold their position.
- 4.11.2. Any Race Car that passes Race Car(s) while rolling around the race Track under yellow lights may be subjected to being put back two positions for each Race Car passed.
- 4.11.3. Following a more serious crash of a Race Car rolling over or if an ambulance appears necessary the Chief Steward will order red lights and flags to stop the Race.
- 4.11.4. Once the red light/flag has been instigated, all Drivers will bring their Race Cars to an immediate safe stop. They are not to pass the accident scene or drive across the Infield past the accident. Any Driver failing to stop may incur a minimum fine of \$100 and/or be sent to the rear of the field for the restart and may be disqualified from that Event and or Race Meeting.
- 4.11.5. Any Race Car stopping due to a red light, but not involved in the incident and not judged to be a contributing cause will be reinstated in the restarting order, regardless of whether a push start is required.  
**SSA – Refer Appendix 3, 4.11.5**
- 4.11.6. Any Race Car judged by the Chief Steward to be the absolute and sole cause of any stoppage will go to the rear of the cars on the same lap in a restart. Any Race Car that requires a second push will go to the rear of the cars on the same lap in front of the primary cause.  
**Lightning Sprints – Refer Appendix 7, 4.11**
- 4.11.7. If the Chief Steward is unable to determine the primary cause of an incident, or judges more than one driver to be at fault, two or more Race Cars may be sent rear of the cars on the same lap, with the Race Cars placed in their previous running order at the very rear of the cars on the same lap. Any Race Car that requires a second push start and is not deemed the primary cause will go to the rear of the cars on the same lap in front of those deemed the primary cause.
- 4.11.8. Any Driver considered by the Chief Steward to have been the primary cause of two stoppages in the same Race will be disqualified from that Race.
- 4.11.9. Any work on Race Cars during a yellow or red light stoppage may be carried out pursuant to rule 4.26 of these rules.
- 4.11.10. Any Race Car/Kart involved in an incident, but judged by the Chief Steward to be completely blameless, unless a Sprintcar, Wingless Sprint or a Speedcar requiring a push start, will be reinstated in the starting order.
- 4.11.11. Any Driver who fails to obey any signal or direction given by the Chief Steward or a Marshal appointed by the Chief Steward may be subject to a fine up to

\$1,000 and/or suspension up to 12 months and/or Disqualification.

#### 4.12. COMPLETE RESTARTS

- 4.12.1. If a first lap stoppage has no obvious cause, except for too many cars/karts on the same area of Race Track, the Chief Steward may order a complete restart with no rear of field penalties applicable, except for Sprintcars, Wingless Sprints and Speedcars where push starts are required.
- 4.12.2. Once the race has started no Driver may switch cars.
- 4.12.3. If a stoppage occurs before the last running car has completed one full lap, a complete two wide restart (or three wide if applicable for a particular division) will be ordered with grid positions as for the initial start, but modified by exclusions and Race Cars sent rear of field. If there are any Race Cars not taking their original starting position then the Race Cars move straight forward to fill the gap.
- 4.12.4. Any Race Car being penalised with a rear of field penalty will restart at the rear of the longest row **in front of any lapped cars.**

**Late Model titles – Refer Appendix 3C, 4.12.5**

#### 4.13. RESTARTS

- 4.13.1. If a stoppage occurs after the last running Race Car has completed at least one full lap, a **restart** will be ordered, with the starting order as for the previously recorded complete lap but modified by exclusions and Race Cars sent rear of field.
- 4.13.2. **The restart procedure of a race is up to the discretion of the Chief Steward and should be outlined clearly to all drivers at the drivers briefing and/or as indicated in any event supplementary regulations. For single file restarts using a cone marker, the cone marker will be located near the Start/Finish Line. The cone should be placed approximately mid-track ensuring that there is sufficient room between the cone and the fence for drivers to safely pass the cone while accelerating. Where a start zone is utilised, it should be indicated and explained to all drivers at the drivers briefing and/or in any supplementary regulations.**
- 4.13.3. Any Driver refusing to accept the restart position directed by the Racing Official will be shown a warning flag for the first refusal, will be sent rear of field for the second refusal and will be disqualified for the third refusal in any one Race.
- 4.13.4. Laps under the caution flag will not be counted on lap score sheets **or on electronic timing.**
- 4.13.5. **When competitors are correctly formed up and a restart is imminent, the yellow lights will be switched off and flags withdrawn. The lead Race Car determines**

the speed of the start but must bring the field to the cone marker or start zone at a constant moderate pace. As the leader approaches the cone marker or start zone, the green light/flag will be shown.

**Lightning Sprints – Refer Appendix 7, 4.13**

**4.13.6. Single File Restarts:**

- a) Where a single file restart is ordered, all Race Cars must approach the cone marker in single file formation and must not commence a passing move until the cone has been passed. Any Race Car that jumps the start, drives in part or wholly beside another vehicle (overlapping) will be relegated two positions at the next stoppage, or if no stoppage, applied in the result of the race at its conclusion. Where a Race Car passes another vehicle and gains a position, they will be relegated two positions for every car passed and therefore position gained.
- b) Any Race Car that passes on the inside of the cone or hits the cone (without dislodging it onto the racetrack) will be relegated two positions at the next stoppage, or if no stoppage, applied in the result of the race at its conclusion. If a Race Car passes another vehicle on the inside of the cone and gains a position, they shall be relegated two positions per car passed and therefore positions gained.
- c) During a single file restart, should the cone be hit and dislodged onto the racetrack by a Race Car, causing a stoppage, the Race Car who hit the cone will be sent to the rear of the field as the primary cause of the stoppage.

4.13.7. A Race Car that has not completed a recorded lap of the Race after any restart shall not re-join the Race at a later stage, including if the Driver was shown a mechanical defect flag.

4.13.8. If a Race is stopped with one lap remaining the restart will be run over two laps (i.e., green, white, chequered).

4.13.9. Any Race Car with a flat tyre is not permitted to restart a race. A Race Car with a flat tyre will be shown the mechanical defect flag and advised via the one-way communicator to withdraw from the race. Should the driver choose to ignore the mechanical defect flag or any advise of the Chief Steward, they will be disqualified from the race.

**Sprintcars - Refer Appendix 1, 4.13**

#### **4.14. WARNING FLAG**

- 4.14.1. Any Driver who is judged by the Chief Steward during a Race to be driving in an overly aggressive manner, to have made careless contact with any other Race Car, to have changed line to impede a passing move or any other act of driving contrary to these rules, will be warned by one-way radio and/or warning flags.
- 4.14.2. If confusion is possible, the Race Car number will be shown with the flag.
- 4.14.3. Having received a warning flag, if a Driver continues to drive in a careless or contrary manner and receives a second warning via a warning flag or through their race receiver, the Driver will be either sent rear of field, or at the Chief Steward's discretion may be given the black flag. The rear of field penalty will be applied at the next stoppage, or if no stoppage, applied in the results of the Race.

#### **4.15. REAR OF FIELD**

- 4.15.1. Any Driver who is advised to go to the Rear of the Field via the one-way communicator during a race stoppage must follow that instruction and go to the rear of the cars on the same lap in the restart. If any confusion is possible, the Race Car number will be shown with the rear of field board.
- 4.15.2. When a Race Car on the lead lap goes to the rear of the field, it goes to the rear of the Race Cars on the same lap as that Race Car with lap cars going behind in the order in which they were running at the last completed lap.
- 4.15.3. If more than one Race Car is sent rear of field, cars which either caused an incident or breached a racing rule, will be placed at the very rear. If more than one car is sent rear for these reasons, the cars will either be placed in their previous race order (at the very rear) or in an order determined by the Chief Steward.  
Race Cars sent rear of field due to needing a push start only, will start at the rear, but in front of the other Race Cars which were deemed to have caused an incident or to have breached a racing rule.
- 4.15.4. Any Driver who refuses to go rear of field when ordered will be disqualified and shown the black flag (see 4.17).

#### **4.16. REAR OF FIELD OFFENCES**

A summary of offences for which a Driver may be sent to the rear of field are listed in Appendix 8 - Penalties Guideline.

#### **4.17. BLACK FLAG**

- 4.17.1. Any Driver who is shown the black disqualification flag, either during the Race or at a Race stoppage must immediately and safely withdraw from the Race. If any confusion arises, the Race Car number will be shown with the flag.
- 4.17.2. Any Driver who fails to comply with a black flag disqualification order or refuses to leave the Race Track when ordered will be served with an Infringement Notice. The minimum penalty for failure to comply with a black flag is a \$300 fine **and** a one-month licence Suspension.
- 4.17.3. Any Driver who continues to ignore the black flag will be fined an additional \$100 per lap **and** the Driver and Race Car will be disqualified from the Race Meeting. The maximum penalty for failure to comply is a \$2,000 fine **and/or** licence suspension of 2 years.
- 4.17.4. Any Driver who elects to dispute an Infringement Notice served due to their refusal to accept the black flag can only dispute the refusal to accept the black flag. The Driver will be unable to dispute the incident that originally led to the black flag or use any aspects of that incident as a defence in the dispute hearing.

#### **4.18. BLACK FLAG (DISQUALIFICATION) OFFENCES**

A summary of offences for which a Driver may be shown a black flag, are listed in Appendix 8 - Penalties Guideline.

#### **4.19. DROPPING OF DEBRIS**

- 4.19.1. Any Race Car that drops any body part, suspension component or other debris on the Race Track which leads to a Race stoppage must go rear of field at the restart, unless it is judged by the Chief Steward not to be that Race Cars fault, in which case that Race Car may be restarted in its previous racing position.
- 4.19.2. Any Race Car that stops after running over another Race Car's debris will not be penalised.
- 4.19.3. **If any part of the top engine cover (bonnet) of a Race Car is lost or damaged and compromises the Driver's safety, the Race Car will be shown the Mechanical Defect flag.**

#### **4.20. LAPPED CARS**

- 4.20.1. When a Race Car receives the lapping flag the Driver of that Race Car must expect to be lapped sometime within the next lap or soon after. The lapped Race Car must hold line (high line or low line) and must not race or impede the lapping Race Car or Race Cars. The lapping flag will continue to be shown to a Driver on each lap that being lapped by any other Race Car is likely.

**Lightning Sprints – Refer Appendix 7, 4.13**

- 4.20.2. If the Chief Steward believes that a lapped Race Car is ignoring the lapping flag by impeding lapping traffic or otherwise not complying with rule 4.20.1, the lapped- Driver may be shown the black flag.
- 4.20.3. Any damaged or disabled Race Car rolling around at a slow speed is to be shown the mechanical defect flag and the Race Car must go immediately to the Infield.
- 4.20.4. In all restarts, lapped Race Cars will be lined up in the order they were running at the last completed lap behind the cars on the lead lap or as directed by the Chief Steward.

**Sprintcars - Refer Appendix 1, 4.20**

**Speedcars – Refer Appendix 2, 4.20**

**SSA – Refer Appendix 3, 4.20**

**V8 Dirt Modifieds – Refer Appendix 6, 4.20**

#### **4.21. STOPPING ON TRACK TO FORCE A STOPPAGE**

Any Driver who, in the opinion of the Chief Steward, has purposely spun or stopped on the Race Track to force a Race stoppage will be automatically disqualified. The Chief Steward's interpretation of a Driver's intent in this regard is final and will not be subject to later discussion or complaint.

#### **4.22. GETTING OUT OF CAR**

- 4.22.1. Following a Race stoppage, until damaged Race Cars are removed to the Infield, Drivers are required to remain in their Race Cars unless there is the risk of fire, or other obvious inherent danger or there is a specific request to get out by the Clerk of the Course/Race Director or Infield Marshal.
- 4.22.2. Unless directed to do so with the approval of the Chief Steward, any Driver who removes or breaks their seat belts or any safety apparel or safety equipment whilst in the confines of the Race Track shall be excluded from the Race. For a second offence during the same Race Meeting, a driver will be excluded from the remainder of the Race Meeting.

**SKAA – Refer Appendix 4, 4.22.2**

- 4.22.3. Any Driver who gets out of a Race Car and walks across a Race Track while cars are moving and/or remonstrate or make any defamatory gesture to any Racing Official, Marshal or other Driver, or who parades in an undignified manner on the Race Track will receive an Infringement Notice and be excluded from the Race Meeting. A minimum fine of \$500 up to maximum fine of \$2,000 and/or up to a maximum 12-month Suspension applies.
- 4.22.4. If a car withdraws from a race and the car remains on the infield, the driver must remain with the car until it is removed, unless they otherwise have permission from the Chief Steward, or require medical attention. The driver may be subject to a minimum \$100 fine and/or disqualified from the race meeting for not following Rule 4.22.4

## 4.23. COMPLETION OF A RACE

- 4.23.1. When a Race Car has passed under the chequered flag the race is considered complete, with remaining cars to continue racing to cross the Start/Finish line until the Chief Steward turns on the yellow lights and calls yellow on the one-way communicator. All Race Cars must then stop racing and slow down in a safe manner and complete a slowdown lap at a reasonable speed.
- 4.23.2. Race results will be determined from the transponder records or lap scorer charts, based upon the order in which the Race Cars cross the Finish Line completing all laps of the Race. The remainder of the field will be classified by the greater amount of laps completed and then the order in which they crossed the Finish Line on the last completed lap. These positions will be subject to any penalties or relegations imposed by the Chief Steward.
- 4.23.3. The Chief Steward will declare a Race complete once the lead Race Car has passed the chequered flag. If the yellow lights/flags are shown after the lead Race Car crosses the Finish Line for an incident all the Race Cars receiving the chequered flag will finish in the order they crossed the Finish Line. The remaining Race Cars will be recorded as finishing in the order of their last completed lap subject to any penalties that are applied by the Chief Steward.  
**SSA – Refer Appendix 3A, 4.23.3**  
**F500 – Refer Appendix 5, 4.23.3**
- 4.23.4. When a Race is completed, placing will be provisional until:
  - a) The lap sheets and/or transponder lap charts have been checked by the Chief Steward;
  - b) The Scrutineers have given clearance to each Race Car and;
  - c) The Chief Steward has declared the results of the Race.
- 4.23.5. When a Race runs over more or less than the advertised number of laps and the chequered flag is shown, the Chief Steward will declare the Race positions in the order of the Race Cars at the chequered flag.
- 4.23.6. For all races, Race Cars that get the green flag to start the Race but are non-finisners will be eligible for points and/or prize money.  
**SSA – Refer Appendix 3, 4.23.7**
- 4.23.7. Any Driver who has received the black flag or is otherwise disqualified from a Race is not eligible for points and/or prizemoney.
- 4.23.8. The Chief Steward may declare complete a final Race in which the lead Race Car has less than one lap to complete the Race or in a non-final Race of greater than eight laps in which the lead Race Car has less than two laps to complete the Race.
- 4.23.9. All prize money must be held until the Chief Steward has declared the results of the Race.

- 4.23.10. A Driver who is awarded a prize that becomes a disputed prize within 14 days of that Race must return that prize to the organisation awarding the prize. The Driver shall be notified of the reasons for the return of the prize. There shall be no grounds for return of a prize after 14 days have elapsed since the running of the Race.

#### **4.24. FEATURE RACES DECLARED SHORT**

- 4.24.1. A feature or final Race must be run over the advertised number of laps, except when rule 4.13.8 applies, unless it is required to be declared short by the Chief Steward due to:
- a) Weather or Race Track conditions;
  - b) Time or noise curfew;
  - c) A serious incident involving injury;
  - d) Any request by the police; or
  - e) Extreme or exceptional circumstances.
- 4.24.2. When feature Races are not completed:
- a) If the feature Race is declared with less than one-half of the scheduled laps completed, all prize-money and series points will be divided equally amongst all starters;
  - b) If the feature Race is declared with at least one-half of the scheduled laps completed, all prize-money and series points will be fully allocated for placings scored as at the last completed lap, modified by any exclusions or rear of field relegations; and

#### **4.25. MECHANICAL DEFECTS**

- 4.25.1. Whether by the Chief Steward's own judgment or on the advice of an Infield Marshal, it is determined that a Race Car cannot safely continue to race, or for any reason is judged to be a potential hazard to other Competitors, the Driver will be shown the mechanical defect flag, together with the Race Car number, if required, to avoid confusion.
- 4.25.2. Upon receiving the mechanical defect flag, a Driver must immediately withdraw from the Race, using utmost caution. Any Driver refusing to withdraw when directed will be shown the black flag. Failure to obey the black flag will result in a penalty in accordance with rule 4.17.2 and 4.17.3.
- 4.25.3. Any Race Car with a flat tyre will be shown the mechanical defect flag.

## **4.26. WORKING ON CARS**

- 4.26.1. At any Race stoppage all work must be performed only on the Infield at the designated work area.
- 4.26.2. If a Race Car requires repairs at a Race stoppage, a time limit of two minutes may be given from the time the Chief Steward approves the request.
- 4.26.3. If work has not been completed in time to restart with the field, the Race Car may re-join the Race at the rear of the field in a subsequent restart if no further completed laps have been recorded.
- 4.26.4. A wheel change (due to a flat tyre) is only permitted for Sprintcars, Speedcars, V8 Dirt Modifieds and Wingless Sprints during a red light/flag stoppage on the first lap of a State or National title or for other major or feature Events where this is approved by a supplementary regulation. Two minutes only will be given for the wheel change. Any Race Car that has had a wheel change will go rear of field in the restart.
- 4.26.5. If the Chief Steward has declared an "Open Red Light" situation during a red light/flag stoppage for a Sprintcars or Speedcars Race only three Pit Crew Members may work on the Race Car. Prior to the opening of the pit gate and allowing Pit Crew Members into the designated work area to work on during an "Open Red Light" situation the Chief Steward must consider factors such as time available, number of Race Cars involved in incident and OH&S responsibilities.
- 4.26.6. Following a Race stoppage when the Chief Steward has deemed the Race Track to be clear the yellow light/flag will signal for Race Cars to be started. Cars may be given two minutes from the time the last ready Race Car to be started has moved onto the Race Track. Race Cars delaying the restart beyond the two minutes and not ready by the time the green is shown shall be excluded from the Race.
- 4.26.7. With the exception of Sprintcars, Speedcars, V8 Dirt Modifieds and Wingless Sprints, the only work permitted on Race Cars after they enter the Race Track is to be done by Infield Marshals and is limited to the removal of damaged body panels and the effecting of repairs using Basic Tools. The Driver must not break his seat belts or get out of the Race Car unless requested to do so by the Clerk of the Course/Race Director or Infield Marshal, otherwise the Race Car will be disqualified.

### **SKAA – Refer Appendix 4, 4.26**

### **Formula 500 – Refer Appendix 5, 4.26.7**

- 4.26.8. Infield Marshals are not permitted to add fuel, oil or water, change wheels (except under rule 4.26.4), wash radiators, do any mechanical adjustments or change any setting.
- 4.26.9. If all Race Cars in an uncompleted Race leave the Race Track and return to the Pits due to any Race delay, when the Race resumes it will be using transponder/lap score placings as recorded at the

stoppage. Race Cars must have been able to restart/re-join the Race at the point of stoppage.

**Sprintcars – Refer Appendix 1, 4.26**

**Speedcars – Refer Appendix 2, 4.26**

#### **4.27. UNAUTHORISED ENTRY TO RACE TRACK**

- 4.27.1. Any Pit Crew Member or other person, proven to be associated with a Driver or Race Car, who enters the Race Track under yellow or red light situations without the express authority of the Chief Steward will be subjected to a \$500 fine. The associated Driver will also be fined \$500 and/or disqualified from the Race Meeting at the discretion of the Chief Steward.
- 4.27.2. Subsequent incidents of unauthorised entry to the Race Track will result in a 12 month Suspension for the offender and a \$1,000 fine and/or Disqualification from the Race Meeting for the Driver.

#### **4.28. REFUELLING**

No Infield refuelling is permitted unless provided for by a supplementary regulation approved pursuant to rule 1.4 and such approval will only be granted for special long distance Events. The refuelling procedures will be specifically detailed in the supplementary regulations and also reiterated during the Drivers Briefing.

**Sprintcars - Refer Appendix 1, 4.28**

#### **4.29. SUBSTITUTE CARS**

- 4.29.1. A substitute Race Car may be used during a Race Meeting by a nominated Driver provided that:
  - a) The substitute Race Car has been nominated for that Race Meeting;
  - b) If the substitution occurs before the Race Meeting (refer to definition of event at the front of this rulebook) has begun, the Race Car starts from the Driver's original drawn position in the heats;
  - c) If the substitution occurs after the Race Meeting has begun, the substitute Race Car starts from the rear of the field in its remaining Heat Races;
  - d) If the substitution occurs after all the heats have been run, the substitute Race Car starts rear of the field in the final Race, providing that the Race Car has competed in at least one previous heat;
  - e) The Chief Steward is notified and has given permission for the substitution;
  - f) If more than one Race Car is used by one Driver in one Event, they are all subject to engine and/or fuel checks; and
  - g) Points will be allocated to the Driver.

**Sprintcars - Refer Appendix 1, 4.29**

**SSA Refer Appendix 3, 4.29**

**SKAA Refer Appendix 4, 4.29**

**F500 Refer Appendix 5, 4.29**

#### 4.30. NATIONAL TITLES AND SERIES AND STATE TITLES

- 4.30.1. To be eligible to compete in a National Title and Series, and State Titles, a Driver must not be provisionally licensed and must have competed in a minimum of two Race Meetings, or more at the discretion of the Affiliated Association or other body conducting the Title (**Organising Body**) in the current season or previous 12 months in the Racing Division for the Title and have their Licence accordingly endorsed by a Chief Steward.
- 4.30.2. At the discretion of the relevant Organising Body, dispensation can be provided if the Driver has driven in an affiliated class or a Racing Division determined by the Organising Body as providing requisite experience, in the current season or previous 12 months.
- 4.30.3. The previous year's champion shall be allowed to defend the title but must compete in the heats. However, if the champion fails to qualify in this manner a rear of field start is permitted in their own or a substitute Race Car.

Heat points for National Racing Divisions Australian and State Titles are as follows:

	SSA & Dirt Mods	SCCA & SKAA	Speedcars	Formula 500	RSA
1	36	22	25	20	33
2	28	19	20	19	26
3	23	17	16	18	21
4	17	15	13	17	18
5	13	13	11	16	15
6	10	11	10	15	13
7	8	9	9	14	11
8	6	7	8	13	9
9	5	5	7	12	8
10	4	4	6	11	7
11	3	3	5	10	6
12	2	2	4	9	4
13	1		3	8	5
14			2		3
15			1		2
16					1

#### **4.31. FIELD SIZES**

- a) Sedan Divisions:  
The absolute maximum field size for all Sedan Divisions is 24 cars.
- b) Open Wheel/Modified Divisions:  
Open Wheel and Modified Divisions are limited to 20 cars; however, some National Titles may allow 21 cars to accommodate the reigning champion if they have not qualified for the main title event.

Please note: Some venues have lower limits, depending on the venue Safety Rating, and some have special dispensation for larger open wheel events in consultation with Speedway Australia.

#### **4.32. PRACTICE PERMIT CONDITIONS**

Practice permits are designed to be a low-risk activity, providing a place for vehicles to be tested and for new participants to learn, away from a non-competitive/racing environment.

- a) A maximum of 6 vehicles on track at any given time.
- b) At the commencement of on-track sessions, vehicles must not form a grid.
- c) Vehicles must be spread out evenly around the track.
- d) Passing must only take place when safe to do so.
- e) Consideration must be given to abilities and skills of drivers when grouping them.
- f) Any departure from these rules will be considered a racing event and will be invoiced accordingly.

#### **4.33. POLE LINE DEFINITION**

INFIELD TYRES:

- a) The pole line must not constitute a hazard to competitors.
- b) No objects are permitted within 10m of the pole line.
- c) The use of objects such as truck, tractor, implement tyres or bundles of car tyres is prohibited.

#### **4.34. LINE MARKING ON INFIELD/PIT AREA**

**Hydrated lime must not be used to mark any area of the infield or pits.**

## 5.1. RECOGNITION OF RACING OFFICIALS

- a) Speedway Australia will administer a Racing Officials Card (physical or electronic) for all Stewards and Scrutineers. A requirement to hold one of these cards is that all Stewards and/or Scrutineers are to be signed off by their club/division and attend a Training Course as recognised by their division. To retain their recognition level, Racing Officials must attend a training refresher course every **three** years (Level 1 and 2 only) whilst also fulfilling all duties, as per Rule 5.1.2.

**SSA - Refer Appendix 3, 5.1**

**The structure of Racing Officials Recognition Levels for Stewards and Scrutineers is provided below:**

### **Chief Steward/Scrutineer (Level 1 – Red)**

Can steward/scrutineer all Race Meetings and Events, including State & National Titles or Series.

#### **To Maintain Recognition:**

- i) Must complete Speedway Australia Online Training every 3 years.
- ii) Must steward/scrutineer at three Race Meetings during their 12-month Speedway Australia licence period.

### **Club Steward/Scrutineer (Level 2 – Orange)**

Can steward/scrutineer all club level Race Meetings or Events.

#### **To Maintain Recognition:**

- i) Must complete Speedway Australia Online Training every 3 years.
- ii) Must steward/scrutineer at three Race Meetings during their 12-month Speedway Australia licence period.

#### **To Upgrade Recognition:**

- i) Must have an "At Track" competency assessment completed by a Chief Steward/Scrutineer which must then be forwarded to the Speedway Australia Head Office within 3 months of the assessment being conducted.

### **Assistant Steward/Scrutineer (Level 3 – Yellow)**

Can assist at all Race Meetings and steward/scrutineer events under direct supervision of a Club or Chief Steward.

#### **To Maintain Recognition:**

- i) Must complete Speedway Australia Online Training every 3 years.
- ii) Must steward/scrutineer at three Race Meetings during their 12-month Speedway Australia licence period.

#### **To Upgrade Recognition:**

- i) Must have an “At Track” competency assessment completed by a Chief Steward/Scrutineer which must then be forwarded to the Speedway Australia Head Office within 3 months of the assessment being conducted.

## **JUNIOR OFFICIALS**

Speedway Australia actively support younger people getting involved as officials and have created the following pathway to support their involvement while ensuring maximum safety, guidance and support for junior officials.

### **Junior Official Aged 12 – 14**

- i) Must hold a Speedway Australia Junior Marshal Licence having completed this online to ensure parent/guardian consent for involvement in the sport has been obtained.
- ii) Must shadow and be directly supervised by Senior Racing Official in a role outside of the Race Track to learn about the Speedway Australia Racing Rules and Regulations, class technical specifications, decision interpretation and communication by officials via one-way and two-way communication devices.
- iii) Must not fulfil a role on the infield of a Race Track.

### **Junior Official Aged 15 – 17**

- i) Must hold a Speedway Australia Junior Marshal Licence having completed this online to ensure parent/guardian consent for involvement in the sport has been obtained.
- ii) Must shadow and be directly supervised by Senior Racing Official in a role to learn about the Speedway Australia Racing Rules and Regulations, class technical specifications, decision interpretation and communication by officials via one-way and two-way communication devices.
- iii) Can perform any role as an official under the direct supervision of a Senior Racing Official.

## 5.2. ELIGIBILITY & CONFLICT OF INTERESTS

- 5.2.1. Any Licence Holder applying for a Racing Officials Card for the first time is required to detail on their application any previous Speedway experience/Record of Prior Learning, to allow their division to consider whether they approve an application for a Licence Holder to become a Level 1 or Level 2 Racing Official.
- 5.2.2. Any Racing Official participating at Events involving Junior Drivers must satisfy any state laws and/or other requirements, where applicable, before officiating.
- 5.2.3. Any Racing Officials working at a Race Meeting must attend the Drivers/Racing Officials Briefing.
- 5.2.4. Any Racing Official who considers themselves to have a conflict of interest with a driver(s) or team at a Race Meeting should make this known to the Chief Steward and Venue Operator prior to the commencement of racing. The Racing Official must ensure that they do not use their position to allow any associated person(s) to gain an advantage of any kind. Should a Racing Official be unable to act in an impartial manner, they should relieve themselves of their duties and inform the Chief Steward and Venue Operator. If a Racing Official is deemed to have allowed an associated person(s) to gain an advantage, they will be relieved of their duties by the Chief Steward or Venue Operator and will be referred to Speedway Australia for disciplinary action.

## 5.3. CHIEF STEWARD

- 5.3.1. For these rules, the Chief Steward is defined as the Speedway Australia or Affiliated Association Licensed Steward who possesses a Speedway Australia Racing Officials Licence and is in charge of the relevant Racing Division for the applicable Race Meeting. At any Speedway Australia or Affiliated Association sanctioned Race Meeting, the Chief Steward for the relevant Racing Division is the sole authority for that Racing Division, for the interpretation and enforcement of these rules in all respects. All other Stewards and Marshals are responsible to the Chief Steward who has the power to direct or instruct such Marshals in the conduct of their duties.
- 5.3.2. Duties and responsibilities of the Chief Steward include:
  - a) The control of all Drivers, Pit Crew Members and Marshals from the time the Participants enter the Speedway Complex (including public areas and car parks) until 30 minutes after the completion of the last Event on the Race Meeting program;
  - b) The briefing of the Drivers prior to the commencement of competition. Details of the Drivers Briefing are shown in rule 5.4 below;
  - c) Briefing the Marshals of the Race Meeting;
  - d) The interpretation and enforcement of these rules;

- e) The power to deal with any incident that occurs at a Race Meeting, whether on or off the Race Track, that is not specifically covered by these rules;
- f) The right to inquire into the circumstances of any incident and to ask any Licence Holder to report to him, and this includes the requirement to act upon any information brought to notice;
- g) The power to order the removal from the Speedway Complex of any person who is interfering with the efficient running of the Race Meeting;
- h) The sole authority to exclude, disqualify, suspend or fine any person, or issue Infringement Notices;
- i) The checking of lap scoring charts and sheets, approval of any alterations to those sheets, the confirmation of any Disqualifications and/or relegations, and the final approval and declaration of all Race results; and
- j) Ensuring that Chief Steward Report is completed at end of the Race Meeting in the form set out and available from [www.speedwayaustralia.org/officials](http://www.speedwayaustralia.org/officials).

#### **5.4. DRIVER'S/RACING OFFICIALS BRIEFING**

- 5.4.1. Drivers and their Race Cars should be at the Speedway Complex a minimum of one hour prior to the advertised starting time although this requirement could be varied through any supplementary regulations.
- 5.4.2. Prior to competition in Speedway Australia or Affiliated Association sanctioned Race Meetings, all Drivers must attend the Drivers' Briefing.
- 5.4.3. Only with the consent of the Chief Steward, may the Race Car Owner or Pit Crew Members attend the Drivers' Briefing in place of the Driver and be responsible for taking notes and then relaying all relevant information to the Driver.
- 5.4.4. The scheduled time for the Drivers' Briefing must be publicised so that all Drivers can ensure that they are present. Unless arrangements have been made in accordance with rule 5.4.3, any Driver who fails to attend the Drivers' Briefing may be penalised by being required to start rear of field in all heats, or other suitable penalty that the Chief Steward may impose. Any Driver failing to attend is responsible for ensuring that he is aware of the content of the Drivers' Briefing and of any supplementary regulations. If applicable, the Driver shall also sign a Release and Indemnity form suitable to the State/Territory laws before being permitted to race.
- 5.4.5. The Drivers' briefing is to include the following:
  - a) Introduction of key Racing Officials & Marshals, particularly the Clerk of the Course/Race Director, Pit Marshalls, Drivers Representative, Scrutineer and any other Marshals determined by the Chief Steward;
  - b) Location of firefighting areas and emergency fire procedures;

- c) Details of any supplementary regulations pursuant to rule 1.4;
- d) Explanation of any Driver introductions or parade laps;
- e) Any other information that the Chief Steward thinks is relevant; and
- f) Reading of the duty of care statement.

## **5.5. CHIEF SCRUTINEER**

- 5.5.1. For these rules, the Chief Scrutineer is defined as the Speedway Australia or Affiliated Association licensed Scrutineer who **possesses a Speedway Australia Racing Officials Licence** and is in charge of the relevant Racing Division for the applicable Race Meeting. At any Speedway Australia or Affiliated Association sanctioned Race Meeting, the Chief Scrutineer is the sole authority for the interpretation of the class specification manual for the relevant Racing Division.
- 5.5.2. All other Scrutineers are responsible to the Chief Scrutineer who has the power to direct or instruct such Racing Officials in the conduct of their duties. However, any dispute between the Chief Scrutineer and a Race Car Owner or Driver is to be referred to the Chief Steward for resolution.

## **5.6. SCRUTINEERING**

- 5.6.1. Prior to competing at a Race Meetings, all Race Cars must be scrutineered by a Scrutineer who may be the Chief Scrutineer or an assistant Scrutineer or technical officer who is responsible to the Chief Scrutineer.
- 5.6.2. During scrutineering, the Scrutineers duties and responsibilities are to check:
  - a) The validity of the Driver's Licence;
  - b) The Driver's Infringement Card, if applicable, for any current suspension or unpaid fines;
  - c) The Race Car's Log Book for previously issued work orders or outstanding items of non-compliance;
  - d) The Race Car for general compliance with the class specification manual applicable for the relevant Racing Division; and
  - e) All safety equipment and protective clothing for compliance with the requirements for the relevant Racing Division.
- 5.6.3. Upon passing scrutineering, the Scrutineer will endorse the Race Car Log Book accordingly and the Log Book will be signed by the relevant Driver and then returned to the Race Car Owner or Driver, or retained until the completion of the Race Meeting depending on the relevant licensing body.
- 5.6.4. Any Race Car that is not presented for scrutineering at least 60 minutes prior to the advertised starting time, may be required to start rear of field in the heats, or other suitable penalty that the Chief Steward may impose.

- 5.6.5. During competition, the Chief Scrutineer or an assistant Scrutineer should be stationed on the Infield as an Infield Marshal to advise upon the serviceability of Race Cars either during a Race or following a crash. In respect to a Race Car's serviceability, the Infield Marshals opinion will be final.
- 5.6.6. At any time during a Race stoppage, a Driver may enter the Infield to enable the Infield Marshal to check the Race Car's serviceability, and then restart the Race without penalty, but if a push start is required, the Race Car will go to rear of field. Work on Race Cars may be carried out in accordance with rule 4.26. *(not applicable to SSA)*
- SKAA – Refer Appendix 4, Rule 5.5.6**
- 5.6.7. At any time during a Race Meeting the Infield Marshal or Chief Scrutineer may request that, following repair work, a Race Car involved in a crash must be re-presented for scrutineering before further competition in that Race Meeting. Incident and outcome to be noted in log book.

## **5.7. INDEMNIFICATION OF SCRUTINEERS**

- 5.7.1. The safety standard of any Race Car, equipment or apparel is a joint responsibility of the Race Car Owner and Driver. Any safety check carried out by a Speedway Australia or an Affiliated Association licensed Scrutineer does not guarantee that the Race Car is without fault and does not absolve the Race Car Owner or Driver of this joint responsibility.
- 5.7.2. The safety check does not impose any level of liability whatsoever upon the Scrutineer, Speedway Australia or any Affiliated Association and no expressed or implied warranty of safety shall result from any safety check carried out by any Speedway Australia or an Affiliated Association licensed Scrutineer.
- 5.7.3. By agreeing to have a Race Car scrutineered, both the Race Car Owner and Driver are deemed to have indemnified the Scrutineer, Speedway Australia and any Affiliated Association against any prosecution, claim, or action for any death, injury, loss or damage arising from any alleged breach of Race Car safety.

## **5.8. CLERK OF THE COURSE/RACE DIRECTOR**

- 5.8.1. The Clerk of the Course/Race Director shall be responsible directly to the Chief Steward for the safe and efficient 'on track' operation of the Race Meeting with duties including:
- a) The responsibility to ensure that prior to Race starts or restarts, ambulance or approved paramedic personnel, flag marshals, track and grid marshals, suitably attired and equipped fire fighters, and push and tow vehicles are at their stations and are ready;

- b) The supervision and co-ordination of the various on track personnel, particularly during driver rescue and wreck removal operations;
- c) The declaration of the Race Track to be 'clear' when all obstructions and debris from a prior stoppage have been removed from the Race Track; and
- d) The performance of other Infield duties as requested by the Chief Steward.
- e) Under the direction of the Steward, assisting the Steward in charge of the Race Meeting with the management and implementation of the Australian Speedway Racing Rules & Regulations.

## **5.9. RACE SECRETARY**

- 5.9.1. The Race Secretary shall be responsible directly to the Chief Steward for the 'off track' operation of the Race Meeting, with duties including:
  - a) Being available to Drivers and the chief Pit Crew Members throughout the Race Meeting to help with queries or concerns relating to the conduct of the Race Meeting;
  - b) Being the first point of contact between Drivers, Race Car Owners and the chief Pit Crew Members with the Chief Steward;
  - c) The responsibility for the supervision of grid draws, the calculation of heat points, determination of grid positions for subsequent Races and the notification of all Drivers of their grid positions and amendments to these;
  - d) The duties of, or supervision of, the Pit Marshall whose duties are to position Race Cars on the dummy grid, advise Drivers of late changes to grid positions, and then to marshall Race Cars onto the Race Track;
  - e) Being available to Drivers and the chief Pit Crew Members to advise on responsibilities and options relating to Infringement Notices, Disqualifications, charges of misconduct, and rights of dispute, and the supply of official Speedway Australia forms; and
  - f) Being available to receive payments for fines and disputes fees, and the endorsing of Infringement Cards accordingly.

## **5.10. ASSISTANT STEWARDS AND TRACK OBSERVERS**

- 5.10.1. Assistant Stewards and track observers are positioned around the Race Track and are in radio contact with the Chief Steward to give advice, as requested on Race incidents. Regardless of the advice so given, the Chief Steward's judgement and decision is final.
- 5.10.2. Drivers, Race Car Owners and Pit Crew Members shall not enter into discussions about any on track incident with the assistant Stewards or track observers, who are responsible only to the Chief Steward and not answerable to Participants.

## **5.11. LAP SCORERS/TRANSPONDER OPERATORS**

- 5.11.1. Lap scorers or transponders shall record the position of each Race Car as it crosses the Finish Line, regardless of whether it is lapped or not.
- 5.11.2. Lap Scorers must be positioned adjacent to the Finish Line to enable Race Car positions to be accurately recorded. *This rule does not apply for Transponder Operators.*
- 5.11.3. During a stoppage, lap scorers/transponder operators shall provide the order of Race Cars scored as at the last completed lap.
- 5.11.4. Lap scorers must ensure that lap-scoring sheets are not altered except by direction of the Chief Steward. Lap scorers/Transponder Operators must also ensure that the Chief Steward approves any alterations and the final results of the Race.

## **5.12. DRIVERS REPRESENTATIVE**

- 5.12.1. The Drivers Representative must be accessible to the Drivers for the duration of the Race Meeting and to assist them without bias or favour.
- 5.12.2. The Drivers Representative is required to attend the Drivers' Briefing and also to liaise between the Promoter and Racing Officials on all matters that have an effect on Drivers.
- 5.12.3. The Drivers Representative must have a current Licence and should be conversant with the relevant racing rules and regulations (including these rules) and be able to advise Drivers on the best method of dealing with matters arising from the conduct of the Race Meeting.

## 6.1. SPEEDWAY AUSTRALIA DRUG AND ALCOHOL POLICY

- 6.1.1. The Speedway Australia Drug and Alcohol Policy applies to all Race Meetings and activities held under the sanction of a track permit issued by Speedway Australia, except for SCCA conducted Sprintcar Racing, where either the Speedway Australia Drug and Alcohol, or the SCCA Drug and Alcohol will apply.
- 6.1.2. Speedway Australia condemns the use of illegal drugs and alcohol in speedway and their use is contrary to the ethics of sport and potentially harmful to speedway participants and others.
- 6.1.3. Speedway Australia has a zero tolerance regarding the use of drugs and alcohol in sport.
- 6.1.4. Each Licence Holder must ensure that any prescribed medication does not contain a Prohibited Substance as listed in rule 6.3.
- 6.1.5. Any individual applying for a Licence or participating in Speedway Australia sanctioned Race Meeting shall be deemed to have consented to any tests for alcohol and Prohibited Substances required by Speedway Australia or its designated administrator.
- 6.1.6. Unannounced testing of Licence Holders for Prohibited Substances and alcohol during a Race Meeting will be conducted from time to time by an independent drug program administrator (**IDPA**). These tests can be conducted under the following conditions:

### **Random Selection Testing**

Random selection testing of Licence Holders for Prohibited Substances and/or alcohol, will be conducted from time to time at the discretion of Speedway Australia and the IDPA. Selection of Licence Holders for testing shall be made at random by the IDPA with all Licence Holders having equal chance of selection. Individuals who are not selected for random testing, but wish to voluntarily participate in testing shall be subject to the same testing requirements and subsequent penalties of selected Licence Holders. Speedway Australia or any Affiliated Association can request random selection testing to be conducted.

### **Critical Incident Testing**

Licence Holders may be required to submit to a procedure for the purpose of testing for Prohibited Substances and/or alcohol following any incident or accident involving injury or death, or when the potential for either has occurred or where there is an accident or damage to property (**Critical Incident**).

### **Cause or Target Testing**

Licence Holders may be required to submit to a procedure for the purpose of testing for Prohibited Substances and/or alcohol where there has been no Critical Incident but where there is a concern that a responsible person is suspected of having recently ingested drugs or alcohol and may be in breach of the Speedway Australia zero tolerance policy.

- 6.1.7. A Licence Holder commits a violation of the Speedway Australia Drug and Alcohol Policy if that Licence Holder refuses to provide a sample for testing when requested by the assigned testing authority.
- 6.1.8. A Licence Holder may be required to submit to a procedure for the purpose of testing for Prohibited Substances and/or alcohol following any incident or accident involving injury or property damage or there is reason to believe that a Licence Holder is affected by alcohol or drugs.

## **6.2. PROCEDURE FOR DRUG TESTING**

- 6.2.1. The testing for Prohibited Substances will be conducted utilising oral fluid (saliva) based drug-screening equipment and can occur any time during a Race Meeting.
- 6.2.2. Those Licence Holders chosen for testing will not be able to participate in the Race Meeting until such time as the test is complete (including until such time a second test is conducted if such a test is required).
- 6.2.3. Failure to produce a suitable sample for testing will be deemed to be a non-negative result, and a serious misconduct or a breach of the Speedway Australia Drug & Alcohol Policy.
- 6.2.4. Drivers who return a non-negative result will be required to present their Licence to the Chief Steward immediately and will be unable to participate any further in the Race Meeting and will not be able to enter any restricted areas for the duration of the Race Meeting.
- 6.2.5. Any Licence Holder other than a Driver who returns a non-negative result will not be able to continue participating in the Race Meeting and will not be able to enter the Pits or any other restricted areas for the duration of the Race Meeting.

### **6.3. PROHIBITED SUBSTANCES**

- 6.3.1. While Speedway Australia reserves the right to change the list of Prohibited Substances the broad classes of substances prohibited in speedway include:
- a) THC (marijuana, hashish);
  - b) Methamphetamines;
  - c) Amphetamines;
  - d) Cocaine;
  - e) Benzodiazepines; and
  - f) Opiates (opium, heroin, codeine, morphine).
- 6.3.2. Licence Holders are required to present to Speedway Australia a written request from a qualified medical practitioner for the use of Prohibited Substances. Speedway Australia will then be the sole authority, in conjunction with their Medical Assessor, to approve the use of the Prohibited Substance. Such approval may only be given if use of the Prohibited Substance is for a therapeutic purpose and will not affect the Licence Holder's judgement. In this respect, it should be noted that most of the psychiatric medications are liable to cause some degree of drowsiness or diminished concentration on performance and the individual response to these drugs is very difficult to predict and the drugs may be taken for many different conditions and in varying dosages.

### **6.4. PROCEDURE FOR ALCOHOL TESTING**

- 6.4.1. The testing for the presence of alcohol in the body is by the analysis of expired air. Testing should be carried out prior to any Race but may be undertaken at any time during the Race Meeting.
- 6.4.2. An initial test will be undertaken and should this test return a positive reading a second test will be undertaken within twenty minutes under controlled conditions to confirm the initial positive test result.
- 6.4.3. Any Licence Holder detected with a blood alcohol content above 0.0 milligrams per 210 litres of air will be declared unfit by the Chief Steward for further participation in the Race Meeting.
- 6.4.4. Any Licence Holder returning a positive breath test result shall be excluded from taking any further part in the Race Meeting by the Chief Steward and, if that Licence Holder is a Driver at the relevant Race Meeting, will be required to attend the Disciplinary Tribunal where they may be subjected to further penalties. Any Licence Holder returning a test result above the required limit will be required by the Chief Steward to leave the Pits or any other restricted area.
- 6.4.5 SSA also refer to Appendix 3**

## 6.5. POSSESSION OF ALCOHOL

The possession on one's person or the drinking of alcohol in the Pits or Race Track area at any time before a Race Meeting, and up until the completion of all competition for the Race Meeting is prohibited. The Chief Steward or their delegate will order the removal from the Pits of any person (including any Licence Holder) in breach of this rule, and if that person is a Driver, Race Car Owner or Pit Crew Member, will immediately disqualify the relevant Driver from the Race Meeting. If the person in breach of this rule is a Driver at the relevant Race Meeting they will be required to attend the Disciplinary Tribunal where they may be subjected to further penalties.

## 6.6. PENALTIES

- 6.6.1. Any Licence Holder alleged to be in breach of a rule in Section 6 of these rules (other than rule 6.1.7) will be served with an Infringement Notice by the Chief Steward requiring:
- a) The Licence holder's SA Licence to be immediately suspended
  - b) The Licence holder appear before a Disciplinary Tribunal
  - c) The Licence holder to be removed from all restricted / controlled area (pits etc.) as soon as practicable
- 6.6.2. If the Disciplinary Tribunal finds a Licence Holder to be in breach of any of the rules in this Section 6 (other than rule 6.1.7) they may impose a penalty on the Licence Holder as per below:
- a) For a first offence under this Section 6 within the last ten years, a maximum penalty of \$1000 fine and two years suspension;
  - b) For a second offence under this Section 6 within the last ten years, a maximum penalty of \$2500 fine and five year suspension; and
  - c) For a third offence under this Section 6 within the last ten years, a maximum penalty of \$5,000 fine and ten year suspension.
- 6.6.3. If a Licence Holder refuses to provide a sample for testing and commits a violation of rule 6.1.7, the Chief Steward will issue an Infringement Notice and the Licence Holder will be subjected to the maximum penalty of ten (10) years suspension and \$5,000 fine.
- Note:** Penalties for an offence under rule 6 are listed in Appendix 8 - Penalties Guideline.

**With respect to the payment of all fines and fees, GST is included.**

## **7.1. INFRINGEMENT NOTICE**

7.1.1. An Infringement Notice is a written notice served by a Speedway Australia recognised Chief Steward or their delegated nominee on any Licence Holder to notify the Licence Holder of an offence punishable by Disqualification, a fine and/or a period of Suspension including any directive that the Licence Holder is to be brought before the Disciplinary Tribunal.

An Infringement Notice for a racing or on track incident is to be served, or the Driver verbally advised, within one hour of the completion of the Race in which the alleged offence occurred and is to include details of any punishment. However, if this is not practical then it should be forwarded to the alleged infringing party (**Defendant**) by hand or registered mail within 7 days of the incident occurring. It may be forwarded by electronic mail but must also be forwarded to the Defendant with hard copy by registered mail. The Defendant will have the right of appeal as specified in Rule 8.1.

7.1.2. For non-race offences, the Infringement Notice should be served by the Chief Steward or their delegated nominee within one hour of the alleged offence being committed. However, if this is not practical then it should be forwarded to the Defendant by hand or registered mail within 7 days of the incident occurring. The Defendant will have the right of appeal specified in Rule 8.1.

7.1.3. When a Chief Steward or a delegated Racing Official issues an Infringement Notice the following should apply:

a) **Top Copy:** to Speedway Australia or Affiliated Association state branch (to accompany any appeal documentation).

b) **Duplicate:** to the Defendant.

c) **Triplicate** retained by the issuing body/Steward.

7.1.4. Any Driver who refuses to receive the Chief Steward's Infringement Notice will forfeit their right to appeal the determination and penalties set out in the Infringement Notice either under these rules or at law.

7.1.5. The Chief Steward will not be required to issue an Infringement Notice for penalties given and carried out during a Race.

7.1.6. The fine and/or period of Suspension will be determined by the Chief Steward and nominated on

the Infringement Notice, except for charges pursuant to a Mandatory Appearance Offence, in which case the matter will be determined and any fine and/or suspension will be set by the Disciplinary Tribunal.

- 7.1.7. A matter set out in the Infringement Notice can be finalised by payment of the fine and/or serving the period of Suspension, as applicable.

**For Competitors/Drivers who receive an infringement notice while competing, a fine should be paid as follows:**

a) Racing class was organised by Host Venue (such as club and club organised blue ribbon events) – fine is to be paid to the Host Venue

b) Class organised by State Based Association (for events such as State Titles) – fine is to be paid to the State Based Association

c) Class is organised by National Association (for events such as National Titles) – fine is to be paid to National Association.

d) Charge is brought forward by Speedway Australia – fine is to be paid to Speedway Australia Head Office.

**For Pit Crew, Mechanics or Officials who receive an infringement while in that capacity, a fine should be paid as follows:**

e) Penalty handed down by the Chief Steward of a Race Meeting – fine is to be paid to the Host Venue where the Race Meeting was being conducted.

f) Charge is brought forward by Speedway Australia – fine is to be paid to Speedway Australia Head Office.

**Process for Payment of Fines is as follows:**

g) Once an infringement notice has been received, contact the respective organisation as indicated above and complete payment of your fine.

h) Once the fine payment has been received, the host club or relevant association is to email the Speedway Australia Head Office and confirm that the fine has been paid, including the amount that was paid and when payment was completed.

- 7.1.8. If a period of Suspension is nominated on the Infringement Notice, further competition at that Race Meeting is not permitted.

- 7.1.9. Any Driver who has a Suspension under an Infringement Notice under appeal in accordance with rule 8.1.4 may only compete at any later Race Meeting only after the appeal has been heard in accordance with Rule 8.1 or if special dispensation is given under rule 7.1.11.
- 7.1.10. If an Infringement Notice is served for any Mandatory Appearance Offence, or any other offence where the Infringement Notice does not set out a Suspension but requires a Licence Holder to appear before a Tribunal, further competition by that Licence Holder is not permitted until the matter has been dealt with by the relevant Tribunal and all judgments have been satisfied unless special dispensation has been given under rule 7.1.11.
- 7.1.11. In circumstances where any delays in conducting a Tribunal could unreasonably affect the future competition of a Driver who has received an Infringement Notice, Speedway Australia or the controlling body of the relevant Racing Division may provide written dispensation allowing competition in future Race Meetings until a Tribunal can be held. The Driver shall not be eligible for any prize money or points until after the Tribunal hearing.
- 7.1.12. Any licence holder who incurs a Suspension will be suspended from any activity at a Speedway venue as a Pit Crew/Mechanic, Racing Official, Marshal and Competitor and, for the avoidance of doubt, may not act in any official position they held from the time the Suspension was imposed to the time the Suspension has expired.
- 7.1.13. Any administrative or typographical errors or omissions by the Chief Steward on an Infringement Notice does not alter the effectiveness of the Infringement Notice and may be subsequently corrected.

## **7.2. VERBAL AND PHYSICAL ABUSE**

- 7.2.1. No Licence Holder at a Race Meeting shall verbally or physically abuse or assault or attempt to physically abuse or assault any person, or use any intimidating or threatening language or actions.
- 7.2.2. Where any person at a Race Meeting receives any form of Verbal or Physical abuse from, or is assaulted by a Licence Holder, this may be reported to any Racing Official or Marshal who shall refer the matter to the Chief Steward, or the Chief Steward directly, who may investigate, and if he deems that a charge is warranted, disqualify the relevant Licence Holder from the Race Meeting and serve an Infringement Notice on the relevant Licence Holder.
- 7.2.3. Where any Driver, Race Car Owner or Pit Crew Member reports verbal or physical abuse or assault from any Licence Holder, unless the abuse or assault has been witnessed by a Racing Official or Marshal who can give an accurate report to the Chief

Steward, the aggrieved person will be advised to lodge a charge of misconduct and therefore have the matter dealt with directly by a Disciplinary Tribunal. Lodging a charge of misconduct requires completion and lodgement of the Request for Disciplinary Tribunal form (as set out in Section 12, 12.2) in accordance with rule 7.5.3.

- 7.2.4. Any Licence Holder who attempts to or verbally or physically abuses or assaults another person whilst at a Race Meeting shall be liable to the fines and penalties as detailed in the matrix below.
- 7.2.5. Any Licence Holder commits an offence other than those listed in the matrix below shall be liable to a minimum fine of \$100 up to a maximum fine of \$5,000 and/or a maximum 2-year Suspension as imposed by the Chief Steward.
- 7.2.6. The penalties in the matrix below as per Rule 7.2.4 or any penalty as per 7.2.5 may be in addition to any misconduct and penalty referred to in Rule 7.5.

### Verbal Abuse/Assault

Severity	Explanation	Penalty
1	Single personalised derogatory comment directed at another individual or group	1 Month Licence Suspension, \$100 fine & 12 Month Probation
2	Multiple personal and derogatory comments directed at another individual or group.	6 Month Licence Suspension, \$500 fine & 12 Month Probation
3	Comment(s) directed at another individual or group with reference to gender, race, culture, sexual orientation or religion.	12 Month Licence Suspension, \$1000 fine & 12 Month Probation
4	Comment(s) directed at another individual or group with threats to harm or kill.	Up to a 24 Month Licence Suspension, \$1000 fine & 24 Month Probation

### Physical Abuse/Assault

Severity	Explanation	Penalty
1	Single slap, punch or kick of another individual.	6 Month Licence Suspension, \$500 fine & 12 Month Probation
2	Multiple slaps, punches, kicks or the use of a weapon of any sort.	12 – 24 Month Suspension, \$1000 fine & 24 Month Probation

### **7.3. CONTROL OF PIT CREW**

- 7.3.1. A Driver shall be held responsible for the appearance and actions of his or her Pit Crew Members and the Race Car Owner for the duration of the Race Meeting whilst those people are at the Speedway Complex.
- 7.3.2. So that the Pit Crew Members for which a Driver is responsible are known and documented, at scrutineering a Driver should submit a list of their Pit Crew Members. It is desirable that all listed Pit Crew Members are in possession of a current Licence. Licence numbers should be included on the list.
- 7.3.3. Conduct by any Race Car Owner or Pit Crew Member that is contrary to rule 7.2 may lead to action by way of Disqualification of the Driver and/or an Infringement Notice being served upon one or more of the Race Car Owner, Pit Crew Member or the Driver.
- 7.3.4. As per Rule 2.2.7, any parent or guardian of a junior driver must hold a minimum of a Speedway Australia Mechanic's Licence.

### **7.4. RECIPROCAL CONDUCT**

All Participants will conduct themselves in a professional and sportsmanlike manner at all times. This is particularly important when in the presence of members of the public. The courtesy expected to be shown to Racing Officials and Marshals by Competitors must be reciprocated by courteous and professional conduct being shown to Competitors by Racing Officials and Marshals.

### **7.5. MISCONDUCT – AT RACE MEETING**

- 7.5.1. A Licence Holder must not engage in misconduct at a Race Meeting. For the purposes of this clause misconduct is defined as any action or behaviour which will bring, or has the potential to bring, the sport of speedway racing or the activities of Speedway Australia or its Affiliated Associations into disrepute.
- 7.5.2. Misconduct under clause 7.5.1 includes but is not limited to assault, intoxication and the breach of the rules, regulations and policies of Speedway Australia, or its members and conduct unbecoming to the sport of speedway.
- 7.5.3. A charge of misconduct:
  - a) A Licence Holder, Speedway Australia and/or another Official (**Complainant**) may refer a charge of misconduct against another Licence Holder to the Disciplinary Tribunal pursuant to these rules.
  - b) A charge of misconduct shall be referred in the form set out at Section 12, 12.2 to the Chief Steward before the expiry of the duration of the Race Meeting.
  - c) A charge of misconduct shall be forwarded by the Host Club or Chief Steward to the secretary of the Affiliated Association or other Club of which the Licence Holder charged with misconduct is a

member, who shall refer it to the executive of the said Affiliated Association or Club within three days, together with a fee of \$500 payable by the Complainant (waived for Speedway Australia and Officials) that is non-refundable if charges are dropped, money to be refunded if charge proceeds.

## **7.6. MISCONDUCT – CHARGE BROUGHT BY SPEEDWAY AUSTRALIA**

7.6.1. Without limiting rule 7.5.1, a Licence Holder must not engage in misconduct or behaviour which is prejudicial to the interest of the sport of speedway. Misconduct for the purpose of this rule is defined as any action or behaviour which is or is not publicly known and in the absolute discretion of Speedway Australia would, or would likely, bring the Licence Holder, the sport of speedway racing, Speedway Australia or an Affiliated Association into disrepute.

7.6.2. Misconduct under clause 7.5.1 includes but is not limited to:

- a) Being charged with, and/or convicted of, a criminal offence;
- b) Being involved in violence or inciting violence;
- c) Intoxication in public;
- d) Making a detrimental, offensive, threatening, discriminatory or false public statement in any media (including social media) about the Chief Steward, a Participant, another Licence Holder, Speedway Australia, or an Affiliated Association and their sponsors, employees or officeholders;
- e) Failure to follow a policy issued by Speedway Australia; and
- f) Failure to follow a reasonable direction of Speedway Australia.

7.6.3. If Speedway Australia believes that a Licence Holder has breached clause 7.6.1 then Speedway Australia may, by notice in writing to the Licence Holder, impose a maximum penalty on the Licence Holder of:

- a) \$5,000; and/or.
- b) 10 year Suspension.

7.6.4. Any fine imposed by Speedway Australia under clause 7.6.3 must be paid to Speedway Australia.

7.6.5. Any charge issued under Rule 7.6 may be appealed as per Rule 8.2.2.

## **7.6.6. SOCIAL MEDIA MISCONDUCT PROCESS**

- a) Social Media Misconduct includes, but is not limited to the following:- misuses of networking, harassing, intimidating or threatening another person by means of posting or sending inappropriate or derogatory email messages, instant messages, text messages, phone messages, images or website posting including those social networking sites such as Facebook, Twitter etc. and is irrespective of whether

the page could be viewed by a broader community or not.

- b) All licence holders must also be aware that postings, comments and/or messages from an individual account, IT tool or mobile phone, whether actioned by themselves or another person will remain the responsibility of the account owner.
- c) Allegations of social media misconduct must be forwarded to the Speedway Australia office, with copies of the appropriate evidence.
- d) A please explain letter will then be issued to the relevant licence holder, giving them 14 days to respond to the charges. Copies of the evidence will be supplied.
- e) Verified offending will be graded in order of severity, with penalties issued in accordance with the following matrix:-
- f) Severity 1 and 2 repeat offenders will be graded at the severity level of 3 or 4. Past and present offences will be reviewed to determine the Penalty severity level to be actioned.

Severity	Explanation	Sanction
1 Mild	Single Post - Throwaway remark, eg 'Speedway Australia are a bunch of clowns'	12 Month Probation
2	Single Post - Personalised abuse eg, 'John Smith is a (profanity) clown'	1 Month Licence Suspension, \$100 fine & 12 Month Probation
3	Multiple Posts - Throwaway remarks at level 1 severity	3 Month Licence Suspension, \$250 fine & 12 Month Probation
4	Multiple Posts - Personalised abuse at level 2 severity	6 Month Licence Suspension, \$500 fine & 12 Month Probation
5	Sustained severe abuse &/ or racial, cultural, gender identity or sexual orientation	12 Month Licence Suspension, \$1000 Fine & 12 Month Probation
6 Severe	Extreme abuse, Death threats	Up to a 24 Month Licence suspension, \$2000 Fine & 24 Month Probation.

- g) Admission of guilt in "please explain" letter may = reduction of 1 grade penalty
- h) Public apology (unprompted) may = reduction of 1 grade penalty
- i) If a licence holder is charged with a severe offence (grades 4-6), they will be suspended until such time as the referral is dealt with.
- j) A penalty issued under this process can be appealed in accordance with rule 8.2.2.

#### **Where do fines paid to Speedway Australia go to:**

All money received from paid fines paid to Speedway Australia go into a fund to assist with Junior Development or Track Safety Grants for upgrades through an application process.

## **7.7. INFRINGEMENT NOTICE OFFENCES AND PENALTIES**

- 7.7.1. The summary of offences for which a Driver will receive an Infringement Notice and the applicable penalties are listed in Part 13 - Penalties Guideline & Appendix 8 – Penalty Matrix.
- 7.7.2. Offences for which an Infringement Notice will be served requiring a mandatory appearance before the Disciplinary Tribunal for determination (**Mandatory Appearances Offences**) are:
- a) A Driver returning a positive alcohol breath test - refer to rule 6.4;
  - b) A Licence Holder in possession of or drinking alcohol in the Pits during a Race Meeting - refer to rule 6.5;
  - c) A Licence Holder under the influence of or in possession of any Prohibited Substance - refer to rules 6.1 and 6.2; and

## **7.8. PROTESTS**

**Sprintcars – Refer Appendix 1, 7.8**

**SSA - Refer Appendix 3, 7.8**

**SKAA – Refer Appendix 4, 7.8**

**F500 – Refer Appendix 5, 7.8**

## **7.9. TECHNICAL**

**Note: The offences in this rule 7.9 are not appealable (see rule 8.1.2)**

- 7.9.1. All Race Cars must comply with the class specification requirements of the relevant Affiliated Association or other controlling body for the relevant Racing Division, as amended from time to time. The Driver is responsible for ensuring the Race Car meets these specifications.  
SSA Sedans - Refer Appendix 3, 7.9.1
- 7.9.2. If at any time during a Race Meeting or during subsequent inspection after a Race Meeting, a Race Car is found to be not complying with the specification requirements the Chief Steward will issue an Infringement Notice to disqualify that Driver and Race Car from the Race Meeting and, in the Chief Steward's discretion, impose a fine of up to \$2,000 and/or a suspension of up to two years on the Driver.
- 7.9.3. Without limiting rule 7.9.2, a minimum penalty of 12 months and a maximum penalty of 24 months suspension and/or a \$2,000 fine may be imposed upon a Driver or other Licence Holder for any of the following:
- a) Any unauthorised person altering or person misrepresenting a Log Book;
  - b) Any person making a false Log Book declaration or knowingly provides wrong information for the registration of a Race Car;

- c) The deliberate destruction of a Log Book;
- d) Any person misrepresenting a Race Car or safety apparel;
- e) Use of any engine, Race Car or other component which offends against the published specifications;
- f) Any person refusing to have their engine checked;
- g) Any use of traction control;
- h) Any abuse of speedway property or safety equipment; or
- i) Any use of illegal fuel or additives.

7.9.4. Sprintcar Technical

**Sprintcars – Refer Appendix 1, 7.9**

7.9.5. SSA Technical

**SSA – Refer Appendix 3, 7.9**

## 7.10. FINES AND PENALTIES

- 7.10.1. Drivers or Race Car Owners who have incurred a fine, fines or penalty for infringement of any of these rules shall not be allowed to compete or, in the case of a Race Car Owner, have their Race Car compete in any subsequent Race Meeting until such time that the fine, fines or penalties are paid in full to the satisfaction of body that issued the fine, fines or penalties.
- 7.10.2. Any suspension period will take effect from the date of the infringement notice. Suspensions however will not be lifted until confirmation is received that any monetary fine incurred, in conjunction with the suspension, has been paid in full. Failure to pay the fine in full will see an extension of the suspension period until such time.
- 7.10.3. A Driver must be notified of an offence or penalty arising from a Race Meeting by either:
  - a) Boards or flags displayed by the Chief Steward or a delegated Marshal whilst the Race is in progress;
  - b) Verbal notification during a Race or at the completion of the Race (including over the race receiver);
  - c) Notification by way of an Infringement Notice issued in accordance with rules 7.1.1 and 7.1.2.
- 7.10.4. Any fine or suspension will be noted on the Driver's Infringement Card, if applicable.
- 7.10.5. Any penalty that is handed down by a Chief Steward during a race (such as a relegation for contact or use of the infield) is not appealable at any time.
- 7.10.6. Any licence holder who receives a penalty in the form of a monetary fine and/or licence suspension whether through the form of an Infringement Notice, Tribunal or Appeal Hearing will have a 12-month good behaviour/probation period added to their licence by Speedway Australia.

## 8.1. APPEAL AGAINST AN INFRINGEMENT NOTICE

- 8.1.1. A Licence Holder may appeal to an Appeal Tribunal immediately, and as per the procedures below, against a penalty imposed by a Chief Steward upon him or her in an Infringement Notice or otherwise.
- 8.1.2. Notwithstanding any other rule or regulation, any breach of the following rules, as determined by Judges of Fact as nominated from time to time, shall be final and binding:
  - a) Race Car specifications (rule 7.9.1);
  - b) Noise requirements (rule 3.5); and
  - c) Technical inspections (rule 7.9.2).
- 8.1.3. The Appeal Tribunal is appointed by the President or equivalent officeholder of the Host Club/Divisional Body and:
  - a) Will consist of three independent members with one to be nominated as Chairperson; and
  - b) Will not consist of anyone who has participated in the subject Racing Division as a Driver, Race Car Owner or Pit Crew Member within the last 12 months.
- 8.1.4. In respect of an appeal against a penalty imposed by a Chief Steward:
  - a) The procedure for instituting an appeal is to lodge the prescribed form (headed "Appeal Form" and set out in Section 12, 12.1) with the Drivers Representative, Chief Steward or Host Club/Divisions within 24 hours of being informed of the Chief Steward's decision (whether verbal or by way of Infringement Notice) together with an appeal fee of \$500 however if the Infringement Notice is only received on a day after the relevant Race Meeting, the Licence Holder shall have 24 hours to lodge the prescribed form with the Host Club/Divisional Body;
  - b) The appeal is to be heard as soon as practicable after receiving the infringement notice once the appeal is lodged;
  - c) An appeal can, at the discretion of the Tribunal Chairperson, be heard via technological means such as a phone link up, conference call (Teams or Skype);
  - d) The appeal shall not operate as a stay of the decision of the Chief Steward the appeal relates to;
  - e) It is recommended for appeals relating to any Championship Events that a secure venue (separate to the Speedway Complex if no suitable venue is available at the Speedway Complex) be utilised to conduct any Appeal Tribunal; and
  - f) The Appeal Tribunal may affirm, overturn or vary the decision appealed against, including a suspended

sentence if appropriate, in such a manner as it shall think fit.

- 8.1.5. The Appeal Tribunal may order that the fee paid upon the lodgement of the appeal be forfeited, reimbursed or partly forfeited and partly reimbursed to the Appellant.

## **8.2 DISCIPLINARY TRIBUNAL**

- 8.2.1. The Disciplinary Tribunal shall hear any charge referred to it under rule 7.5 and any Mandatory Appearance Offence.

- 8.2.2. In respect of a charge of misconduct under rule 7.5 and any Mandatory Appearance Offence:

- a) The Tribunal Chairperson may consider a plea bargain. The Tribunal Chairperson and the Defendant can arrange to settle the case against the Defendant without conducting a hearing, where the Defendant agrees to plead guilty in exchange for an agreement from the Tribunal Chairperson as to the penalty. A plea bargain requires adequate consultation with the Defendant and the relevant Host Club/Divisional Body. The Tribunal Chairperson must seek the views of the Defendant and the relevant Host Club/Divisional Body about plea bargaining prior to determining the penalty. Once an agreement has been reached by both parties there can be no appeal against this decision;
- b) Within 14 days of being appointed, the Disciplinary Tribunal shall set an appropriate date and place for the hearing of the charge;
- c) A charge may only be heard by the Disciplinary Tribunal if the person charged has been informed via a read receipt email sent at least 7 days prior to the hearing of the charge of the following particulars:
  - i) The nature of the charge and;
  - ii) The factual basis upon which the charge is preferred against the Appellant/Defendant.
- d) The Disciplinary Tribunal may, in its' absolute discretion, impose any penalty it thinks fit for a charge arising from the charge including a suspended sentence so long as such penalty does not exceed the maximum (if any) prescribed in these rules) and any suspension period applied as a penalty cannot reduce the minimum suspension (if any) as prescribed in these rules and;
- e) Where a Licence Holder has been found guilty of a charge they may, at the discretion of the Disciplinary Tribunal, be liable to pay all reasonable costs incurred by the Host Club/Divisional Body in hearing the matter as determined by the Disciplinary Tribunal.

- 8.2.3. It is the responsibility of the Appellant/Defendant to provide to the hearing any witnesses and/or evidence, including video evidence he/she may choose to present as allowed by the Disciplinary Tribunal Chairperson.

- 8.2.4. Other than by way of appeal under rule 8.3, the decision of the Disciplinary Tribunal shall be final and there shall be no further avenue for appeal or recourse to any court in relation to any aspect of the decision. The finality of the appeal must be acknowledged by all Appellants in writing prior to the commencement of the appeal hearing in accordance with the Appeal Form in Section 12, 12.1.
- 8.2.5. Where any inconsistency arises between this rule 8.1 and any Host Club/Divisional Bodies' rules with respect to the conduct of the Disciplinary Tribunal, the rules contained herein shall prevail.
- 8.2.6. A decision of the Disciplinary Tribunal may be appealed to the Speedway Appeal Tribunal provided that rule 8.2 is satisfied.

### **8.3 SPEEDWAY APPEAL TRIBUNAL**

- 8.3.1. A person may appeal against the decision and/or penalty of a Disciplinary Tribunal to the Speedway Appeal Tribunal if the penalty handed down or upheld by the Disciplinary Tribunal includes:
- a) A fine in excess of \$1,000; or
  - b) A period of licence suspension in excess of 12 months.
- 8.3.2. A person may appeal against the penalty set down by Speedway Australia under rule 7.6 to the Speedway Appeal Tribunal if the penalty handed down includes:
- a) A fine in excess of \$1,000; or
  - b) A period of licence suspension in excess of 12 months.
- 8.3.3. Any person who wishes to appeal against the decision of a Disciplinary Tribunal or Speedway Australia under rules 8.3.1 or 8.3.2 shall:
- a) Give written notification (via email) of their intention to appeal to the Speedway Australia Head Office within 24 hours of the relevant decision; and
  - b) Lodge a written appeal with this to the Speedway Australia Head Office in the form of Section 12, 12.3 together with a fee of \$1,500 within 14 days of the conclusion of the Disciplinary Tribunal or handing down of the penalty by Speedway Australia. An appeal may be lodged by another person acting on behalf of the aggrieved party where the aggrieved party is injured or otherwise unable to lodge the appeal themselves.
- 8.3.4. The Speedway Appeal Tribunal shall consist of three independent members who are appointed by Speedway Australia and comprise the following membership:
- a) No person who was participating at the relevant Race Meeting as a Race Car Owner, Driver, Pit Crew Member, Racing Official or Marshal (if applicable), or who is directly or indirectly concerned with the matter under consideration;
  - b) No person who is an employee or officeholder of Speedway Australia; and

- c) Where appropriate to the particular appeal, a person knowledgeable about the conduct of speedway racing or the technical specifications.
- 8.3.5. The Speedway Appeal Tribunal may be appointed for a period of time, or from time to time, although some commonality of membership and consistency of approach is desirable.
- 8.3.6. Speedway Australia shall elect a chairperson of the Speedway Appeal Tribunal.
- 8.3.7. The Speedway Appeal Tribunal shall:
- a) Satisfy itself that the appeal is eligible to be heard by the Speedway Appeal Tribunal and proper documentation has been completed within the prescribed time limits and accompanied by the appropriate fees;
  - b) Dismiss the appeal if the proper documentation, time limits and fees have not been complied with, unless the default in documentation is of a minor nature;
  - c) Ensure that all parties have been given adequate notice of the hearing, such notice being not less than 7 days, unless otherwise agreed by all parties, including notice of the right to call witnesses and present any other relevant evidence;
  - d) Ensure a recording of the hearing to be taken and retained by Speedway Australia (and each Licence Holders consents to such recording); and
  - e) Maintain a record of the matters heard by the Speedway Appeal Tribunal and communicate to Speedway Australia and the Appellant any decision of the Speedway Appeal Tribunal, including its reasons for decision as soon as practicable after a decision has been made.
- 8.3.8. The Decision of the Speedway Appeal Tribunal is as follows:
- a) The Speedway Appeal Tribunal will decide that a decision appealed against be upheld or dismissed or substituted by another decision and that the penalty appealed against be waived, mitigated, increased or a fresh penalty imposed, but it shall not order any Event or Race to be re-run.
  - b) The Speedway Appeal Tribunal may consider a Suspended Sentence.
  - c) Any decision of the Speedway Appeal Tribunal shall be final and there shall be no further avenue for appeal or any recourse to any court in relation to any aspect of the decision.
  - d) The Speedway Appeal Tribunal may order that the fee paid upon the lodgement of the appeal be forfeited, reimbursed or partly forfeited and partly reimbursed to the Appellant.
  - e) The Speedway Appeal Tribunal may order that an unsuccessful Appellant pay the reasonable costs of any other party where it judges the appeal to have been vexatious or frivolous or brought without reasonable grounds.

## 8.4 TRIBUNAL PROCEDURE

- 8.4.1 Each Tribunal will be bound by the following requirements:
- a) It must observe the principles of natural justice and provide the Appellant or Defendant with the opportunity to be heard and to make submissions in relation to the alleged charge and any proposed sanction;
  - b) It is not bound by the rules of evidence usually applicable to proceedings in a court of law and may inform itself on any matter in such manner as it thinks fit;
  - c) It will conduct its hearings with as little formality and technicality and with as much expedition as the proper consideration of the matter permits;
  - d) Hearings may occur in such manner as the Tribunal Chairperson decides, including by telephone or video conferencing;
  - e) The parties to an appeal or hearing before a Tribunal will not be entitled to be represented by a barrister or solicitor or any other legal representation unless:
    - i. With the leave of the Tribunal, which leave will only be given in exceptional circumstances and, if given, may be given unconditionally or on such conditions as the Tribunal thinks fit; or
  - f) Where the Appellant or Defendant holds a Junior Licence and then only a parent/guardian is permitted to represent the Appellant or Defendant;
  - g) It will allow Licence Holders to call upon any person or persons to give evidence, or provide any video/photographic evidence, which it deems necessary to reach an unbiased and lawful decision however such witnesses shall only be present at the hearing when giving evidence (unless they are one of the parties to the hearing);
  - h) It may adjourn the hearing of an appeal or charge if it considers such an adjournment appropriate in the circumstances and;
  - i) It will give its decision, and may give an oral decision, as soon as practicable at the conclusion of or after the hearing and will provide the parties to the appeal or hearing with a statement of the reasons for its decision as soon as practicable after the hearing.
- 8.4.2 No Tribunal shall have the authority to order any Event or Race to be rerun and the final decision of the Chief Steward during an Event or Race regarding a field of play decision shall not be reviewable unless the decision was made outside of the Chief Steward's authority or was the product of fraud, corruption, partiality or other misconduct of the Chief Steward.
- 8.4.3 To the extent that it is not prescribed by these rules, the Tribunals shall determine its own procedure.
- 8.4.4 In addition to any other means of giving notice, any notice required to be given to a Defendant or Appellant under this Part 8 will be taken to have been

given properly if it is delivered or sent by ordinary pre-paid post or email to the address notified to Speedway Australia in respect of the Licence Holder's last application for a Licence. A notice will be taken to have been given:

- a) If posted, on the third day following the date of posting (whether actually received or not);
- b) If by email, at the time of transmission/sending unless a message stating that the email failed to reach the intended recipient is received by the sender.

8.4.5. In the event that the Appellant/Defendant fails to attend or make suitable arrangements for the adjournment of any tribunal or appeal hearing, the hearing can be held in their absence and any decisions and/or penalties handed down by the hearing will be final.

8.4.6. Speedway Australia reserve the right to refer any complaint or charge to the National Sporting Tribunal to conduct an independent investigation or hearing to conclude a resolution to be referred to Speedway Australia for penalty. This penalty will include all attributed or associated costs involved with the National Sporting Tribunal.

## 9.1. DEMOLITION DERBY RULES AND REGULATIONS

Demolition Derbies are intended to provide safe competition and enjoyment for the participants and spectacular entertainment for spectators.

At all times the Steward's decision shall be final and no protests or appeals will be considered by Promoter. The Promoter has the right to refuse the entry of any driver.

**ALL** competitors must hold a valid Speedway Australia full competition or one day licence to compete in any extraneous event.

**See separate rules for a Main Straight Derby.**

## 9.2. SAFETY REQUIREMENTS

- 9.2.1. Full faced helmet with visor must be worn which meets or exceeds AS/NZS 1698:2006 or UN ECE 22.05 standard.
- 9.2.2. Neck Brace must be worn – SFI Foam collar to be used.
- 9.2.3. One piece driving suit or one piece cotton drill overalls to be worn with covered footwear. No synthetic or nylon clothing allowed. No exposed skin allowed. All drivers must wear full length, long sleeved overalls. Leather gloves, boots or shoes must be worn, **NO THONGS or SNEAKERS. NO NYLON CLOTHING**
- 9.2.4. No thongs to be worn in pit area during meeting
- 9.2.5. Gloves of fire retardant material to be worn.
- 9.2.6. Padding to be placed on all bar work and protrusions to protect the driver
- 9.2.7. Window net for driver door mandatory. Net to be secured at bottom and clipped at top. Maximum hole size in webbing 75mm x 75mm.
- 9.2.8. Centre of steering wheel to be padded, with airbags disconnected or removed.
- 9.2.9. Driver's side door to be painted red with large white cross.
- 9.2.10. If passengers participate the same safety requirements for the drivers must be adhered to, for example passenger's door to be painted red with white cross and window net to be fitted.

## 9.3. MINIMUM AGE

No person under the age of 16 years (under 17 years in NSW) shall ride in, drive, or be in charge, of any motor vehicle during the conduct of the event.

## **9.4. DRUGS AND ALCOHOL**

- 9.4.1. Drivers may be required to submit to an alcohol and/or drug test before the event and pit crew may also be tested at random. Drivers must be able to return a result of 0.0 or a negative reading.
- 9.4.2. No drinking of alcohol in the pits until the completion of the meeting.

## **9.5. VEHICLE REQUIREMENTS**

Vehicles can be any Sedan, Station Wagon, Panel Van or Utility. Please note, however, that no full chassis vehicles are permitted ie vehicle where the chassis can be unbolted or separated from the body for the full length of the vehicle. Only original manufacturers body panels and equipment to be used in its entirety.

- 9.5.1. V8 vehicles are not encouraged
- 9.5.2. Uniform engine capacity specification (i.e. 8, 6 and 4 cylinder vehicles not to be combined).
- 9.5.3. Vehicle must use original type manufacture engine and transmission mounted in original position
- 9.5.4. Engine and gearbox mounts may be welded and/or restraint chains or cables are permitted but original rubber mounts must be retained
- 9.5.5. Engine fan may be removed if desired.
- 9.5.6. Type and means of gear shift is optional but hole must be less than 200mm x 200mm if fitting floor shift.
- 9.5.7. No extra weights or reinforcing of suspension parts
- 9.5.8. No relieving of guards or panels to allow greater wheel clearance
- 9.5.9. All holes in the firewall and front floor are to be covered
- 9.5.10. Bumpers must be for type and model of vehicle being used and all over-riders must be removed
- 9.5.11. Grills must not be replaced with any material considered to be stronger than original.
- 9.5.12. Tow bars and bull bars to be removed
- 9.5.13. All glass must be removed
- 9.5.14. All interior linings, trims, interior/exterior door handles, ornaments chrome strips and lights to be removed
- 9.5.15. Windscreen mesh to be securely fitted using 75mm x 75mm x 5mm mesh (min).
- 9.5.16. All doors and tailgate to be chained shut around door pillars using 6mm chain and bolted using 10mm bolts. Chain to go twice around door pillars and be bolted. Both front doors to be securely chained (6mm), bolted or welded shut.
- 9.5.17. If vehicle has tailgate it must be chained closed with 6mm chain and bolted using 10mm bolts.
- 9.5.18. Car numbers to be 600mm high x 400mm wide and 100mm thick clearly written on each side of car behind front door.
- 9.5.19. No obscene or offensive sign writing on cars.
- 9.5.20. Driver's side door to be painted in contrasting colour with large white cross

- 9.5.21. Drivers Name to be printed clearly on the roof above the driver
- 9.5.22. Vehicles may be fitted with a 300mm x 300mm white flag attached to 6mm wooden dowel so that bottom of flag is no lower than 300mm above roof line when dowel is attached with tape to right hand door pillar. Driver is to break flag off as soon as their vehicle is immobilised indicating that the vehicle is no longer in the event and is no longer a target.

## **9.6. SEATS AND SEAT BELTS**

- 9.6.1. A seat incorporating a headrest must be used.
- 9.6.2. Seat back to be hard against and fixed to a horizontal brace attached to roll cage.
- 9.6.3. Road type regulation lap and shoulder harness securely fixed is a minimum.
- 9.6.4. Belts to be in good condition and repair.
- 9.6.5. Competition 75mm 4, 5 or 6 point harnesses are permitted and recommended. If race harness is used, it must be mounted to roll cage.

## **9.7. FUEL SYSTEM**

- 9.7.1. Original fuel tank must be removed.
- 9.7.2. Jerry can or boat type fuel tank minimum permitted, maximum capacity 20 litres
- 9.7.3. Pick up and breather pipes to enter top of tank.
- 9.7.4. No electric fuel pumps unless original manufacturer equipment
- 9.7.5. Fuel tank to be securely mounted to bar work with steel straps or similar in back seat area.
- 9.7.6. Fuel line to have flexible section close to tank
- 9.7.7. Tap to be fitted in line within reach of driver and clearly marked in a contrasting colour – FUEL ON/OFF
- 9.7.8. A non-spill vent is to extend through floor well clear of exhaust pipe. Fuel tank must otherwise be sealed.

## **9.8. OTHER MECHANICAL REQUIREMENTS**

- 9.8.1. Radiator (and transmission cooler if original) must be used and flowing & fixed to original mounting points.
- 9.8.2. Additional radiators, transmission cooler or holding tanks not permitted.
- 9.8.3. Brakes, steering and exhaust to be roadworthy. All cars to be below 95 DBA.
- 9.8.4. Tail shaft loops to be fitted within 150mm of universal joints
- 9.8.5. Locked differentials are optional.

## **9.9. ELECTRICAL SYSTEM**

- 9.9.1. Battery to be mounted to bar work in left side of car. MUST be securely fitted in box and sealed with rubber.
- 9.9.2. Two secured batteries may be used.
- 9.9.3. Effective kill switch to be mounted in centre cowl panel & marked in contrasting colours KILL SWITCH.
- 9.9.4. All wires to be suitably grommeted where they pass through firewall.
- 9.9.5. Wires not to be attached to fuel lines.

## 9.10. WHEELS AND TYRES

No racing rims or racing tyres permitted

## 9.11. ROLL CAGE AND CONSTRUCTION REQUIREMENTS

Also refer to diagram below

- 9.11.1. All bar work to be minimum 38mm x 3.2mm black steel pipe – max 50mm x 3.2mm steel pipe.
- 9.11.2. Bar work to be in cabin area only.
- 9.11.3. All plates and washers to be 100mm x 100mm x 3.2mm minimum thickness.
- 9.11.4. All bolts to be 12mm minimum.
- 9.11.5. Main bar to be one piece and mandrel bent only not heat formed. No galvanized pipe permitted. Bar to be placed as close as possible to the rear of the driver's seat.
- 9.11.6. The bars of the roll cage to be mounted securely and bolted to the floor pan using 12mm bolts minimum and 100mm x 100mm x 3.2 mm plates
- 9.11.7. All joints to be professionally welded
- 9.11.8. Main roll bar to have horizontal brace bar at approx. just below shoulder height.
- 9.11.9. One rearward brace bar only, from top centre of main hoop to a plate bolted in rear of car.
- 9.11.10. Side intrusion bars on both side to be bolted to wheel well and extend back to main roll bar at centre door height.
- 9.11.11. Drivers side only to have 6mm steel plate one piece attached to both front door pillars and the side intrusion bar, using 12mm U bolts (No drilling of bar work) and or angle iron brackets and 12 mm bolts or welded. Plate must extend from bottom of door to window opening.
- 9.11.12. Padding to be placed on all bar work and protrusions to protect driver.

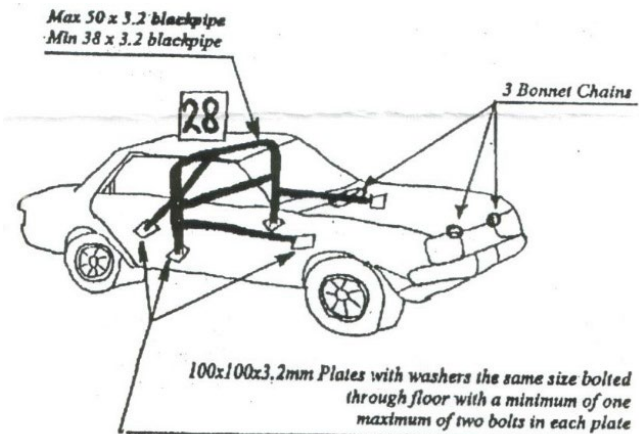

### 9.11.13 Option Two: Approved alternative rollbar

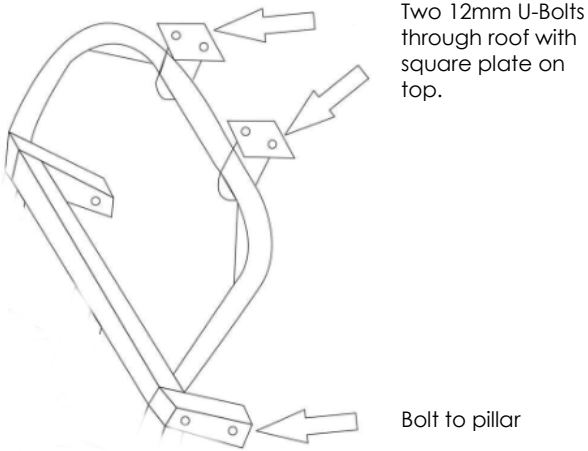

- a) Minimum specifications for round pipe:-  
38mm x 3mm wall thickness
- b) Minimum specifications for RHS:-  
65mm x 65mm x 3mm wall with 100x100 triangle gussets in the corners
- c) Minimum specification for U-Bolts: 12mm

## 9.12. DEMO DERBY RACING RULES

- 9.12.1 All cars must be at the track at the allocated time and date to be scrutineered. Any cars not passed will have the opportunity to correct any problems and be re-inspected prior to event. Cars that are not in pit area by specified time will not be eligible to compete until scrutineering fee is paid.
- 9.12.2 Crash helmets and seat belts must be worn at all times during the event until the event has been completed.
- 9.12.3 The track is to be watered before the Demolition Derby commences to reduce dust and speed.
- 9.12.4 The event is started when RED light is turned Green or Green flag is dropped. The Racing Official may at any time change the lights back to RED in the event of an accident or fire. All action must cease immediately when the Red light is on or RED flag waved.
- 9.12.5 Any car immobilised for longer than two minutes will be deemed to be out of the event. Driver must remain strapped into car until told by a Racing Official or Marshal to vacate car.
- 9.12.6 If given a black flag a driver must immediately cease driving.
- 9.12.7 If vehicle has tail gate which opens or is lost during the event that vehicle is disqualified immediately.
- 9.12.8 Any car deemed by Racing Officials not to be actively participating in the demolition of fellow competitors and making solid contact with another MOBILE

vehicle at least every two minutes will be automatically disqualified.

- 9.12.9 Drivers who drive outside of designated competition area will be disqualified.
- 9.12.10 Any competitor deemed to have hit on purpose a fellow competitor driver's door or driven into roof of an over turned car will be instantly disqualified.
- 9.12.11 It is recommended that First and reverse gears are to be used only.
- 9.12.12 Last car still MOBILE as judged by the Racing Officials will be deemed to be the winner provided that all rules have been observed.
- 9.12.13 The winning car will be re-inspected after the event before official result is given.
- 9.12.14 Decisions of the Racing Officials are final and no protest will be considered.

### **9.13. SALVAGE**

It is responsibility of each entrant to remove their vehicle from the Speedway premises within 24 hours of the event. Any vehicle left on Speedway property overnight is at owner's risk. Any cars not removed within 24 hours will become the property of the Promoter and will be disposed of in any manner they select.

### **9.14 DEMO DERBY TEAMS RACING: ADDITIONAL TECHNICAL SPECIFICATIONS**

- 9.14.1 All cars to be tidy in appearance and professionally sign written.
- 9.14.2 All glass except interior mirror to be removed.
- 9.14.3 Cars that contain rust in critical areas e.g. door pillars or hinges will not be permitted.
- 9.14.4 Side intrusion bar to be fitted between drivers door pillars (same size and material as roll bar).
- 9.14.5 All vehicles must be fitted with an interior roll bar (not full cage) fitted behind the front seat, above the drivers normal seated position, as per diagram over.
- 9.14.6 Rollbar material: 38mm OD 3.2mm wall thickness steampipe or RHS.
- 9.14.7 Diagonal cross must be fitted inside roll bar.
- 9.14.8 Rollbar to be mounted to mounting plates at floor and middle of roof.
- 9.14.9 Mounting plates to be 125mm x 125mm x 6mm.
- 9.14.10 A headrest 280mm x 150mm x 3mm to be fitted centrally behind drivers helmet and securely mounted to rollbar.
- 9.14.11 Radiators to remain in original position but fan may be removed.
- 9.14.12 Fuel tanks must be mounted in the boot area centrally and as far forward as possible without intruding into the rear passenger area.
- 9.14.13 Fuel lines to be secured with no leaks or kinks and of

an approved type.

- 9.14.15 All bolts used to effect modification are to be a minimum of 10mm in diameter.
- 9.14.16 Car only to carry 10ltrs of fuel
- 9.14.17 Electric fuel pumps must have a shut off switch accessible from outside the vehicle
- 9.14.18 Must have a 4, 5 or 6 point racing harness (harness must be serviceable but may not be in date)

Pictured below: Roll bar as required in Teams Derby Rules 9.14.5 – 9.14.10

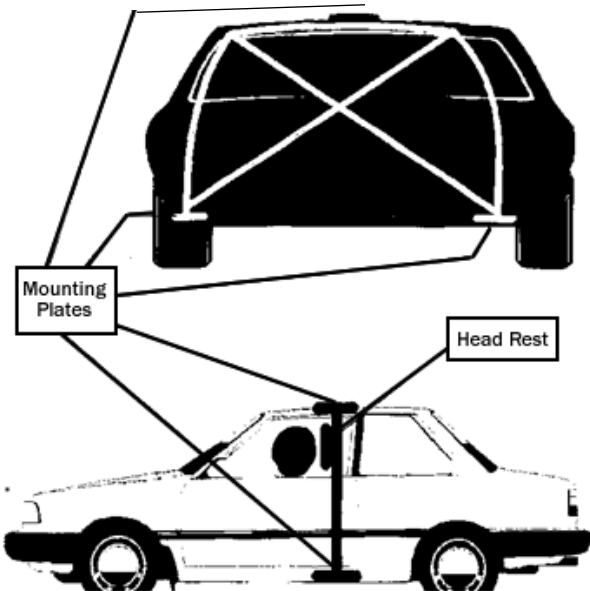

- 9.14.16 Derby Teams Rollbar Option B – as per diagrams below
  - a) 50x50mm RHS 3mm wall thickness plates on sides and floor and roof 300mm x300mm x 3mm thick.
  - b) A side intrusion bar on the driver's side should run from front of front door pillar to rear of rear door pillar at centre door height.

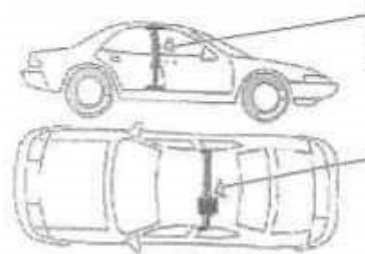

095 Rollover post. Flat plate welded top and bottom. Bolted through roof and floor

095 pipe behind drivers seat, welded from B-pillar to B-pillar

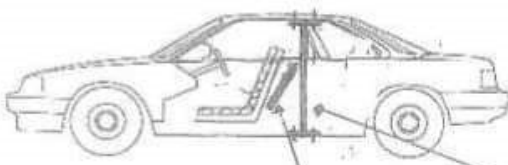
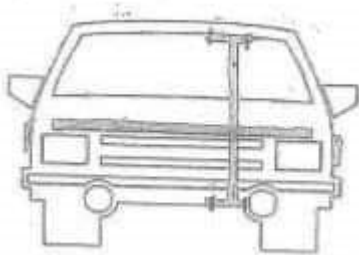
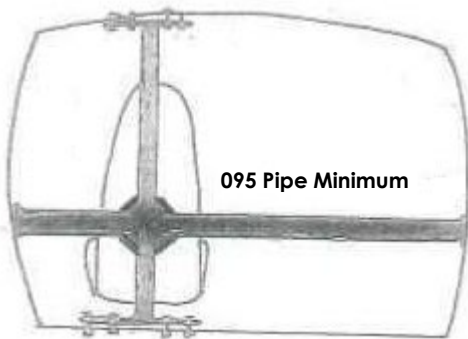

**B-Pillar to B-Pillar bar**

**Rollover post can be behind B-Pillar bar**

**9.15 DEMO DERBY TEAMS RACING:  
ADDITIONAL RACING RULES**

- 9.15.1 Racing may take place during the meeting.
- 9.15.2 No competitor shall manoeuvre their vehicle into the path of others, so their door is exposed.
- 9.15.3 No hitting any stationary vehicles
- 9.15.4 All competitors must race in the race direction.
- 9.15.5 In the event of a rollover the car is out of the race unless it returns to its wheels without assistance.
- 9.15.6 Teams will consist of 2 to 4 members at the promoter's discretion
- 9.15.7 One way communication to Chief Steward is required.

## 9.16. DEMOLITION DERBY RULES AND REGULATIONS

**PLEASE READ THE FOLLOWING RULES CAREFULLY-ALL RULES WILL BE STRICTLY ENFORCED.** Note: All vehicles must be in standard condition except for modifications allowed in these specifications.

- 9.16.1. Format: Forward only slalom Demo Derby for front wheel drive 4 Cylinder with a maximum capacity of 1.8 litre
- 9.16.2. Open to Front Wheel Drive 4-cylinder vehicles ONLY eg: Hyundai Excel, Daewoo, Ford Laser, Mazda 323, Suzuki, Swift, Daihatsu Charade, Toyota Corolla – if you're not sure please seek clarification on cars.
- 9.16.3. NO PASSENGERS ARE ALLOWED
- 9.16.4. No relieving of guards or panels to allow greater wheel clearance
- 9.16.5. Diff's are open
- 9.16.6. Wheels and tyres are not restricted – All wheel weights must be removed.
- 9.16.7. All mouldings, head lights, tail lights and badges must be removed (NOT BROKEN)
- 9.16.8. All glass must be removed properly, NOT BROKEN IN. PLEASE NO GLASS fragments left in vehicle.
- 9.16.9. All cars are to be cleaned out (no loose objects)
- 9.16.10. All doors must be tied with Seat Belts or chained, and not lightened or cut out ie. Not altered in any way. • Window mesh in front of driver's door optional
- 9.16.11. Webbing strap or chain for the extreme front of bonnet is acceptable. No bolting, welding or strengthening of any bonnet, boot lid, mudguard, bumper bar or seam.
- 9.16.12. No tow bars.
- 9.16.13. Battery must be securely mounted, covered with RUBBER MATTING
- 9.16.14. Radiators must be of original type and in original position.
- 9.16.15. Fan blades may be removed.
- 9.16.16. No additional heater tanks, radiators or top-up bottles.
- 9.16.17. Fuel Tanks -If original tanks are used a maximum of 20 litres of fuel can be carried
- 9.16.18. Fuel Tanks - alternative tank must be a steel "jerry can or outboard motor fuel tanks", which must be secured to the middle of the rear seat on the floor in a safety cradle. Original must be holed.

- 9.16.19. Absolutely No plastic bottles permitted.
- 9.16.20. The original fuel line must be used from the engine bay to the entrance of the fuel tank where an approved one metre (maximum length) flexible fuel hose may be used. Professionally constructed – no plastic tanks.
- 9.16.21. Located immediately behind the driver's seat one tube steel bar from pillar to pillar (centre pillars or rear doors OK) must be used. Round Tube or Square tubing must be at least 38mm x 3.0mm. A Vertical bar may be used behind the driver's seat from roof to floor with a plate or a rope from pillar to pillar to stop right hand seat collapsing.
- 9.16.22. On the end of each bar plates of not less than 100mm x 100mm are to be welded on each end and bolted to pillars (not welded) by at least two bolts each side through pillars or rear doors and plates. Bolts must be no less than 6mm thick and bolted from outside inwards.
- 9.16.23. Approved seat belts must be fitted to the vehicle – Standard vehicle seatbelts are allowed or proper fitted Competition four-point harness are permitted and recommended.
- 9.16.24. Belts must be in good condition -i.e. no frayed edges.
- 9.16.25. Car numbers must be in large lettering on both sides of the vehicle. Preferably, both passenger doors.
- 9.16.26. The driver's door must be painted RED OR WHITE WITH A LARGE WHITE X (CROSS) OR NUMBER to be a contender in event. No X/Number = No start.
- 9.16.27. All sign writing will be inspected. Anything deemed to be in bad taste by the Racing Officials must be removed.
- 9.16.28. Any foam cushioning is acceptable and recommended
- 9.16.29. All brakes must be in working order

## 9.17 MAIN STRAIGHT DERBY RACING RULES

Note for Promoters: For a derby between 20 to 30 cars, the track size is recommended to be a maximum of 75 to 100 metres long and 40 to 50 metres wide. The track size may be increased with higher car counts.

- 9.17.1 Open to all competitors, male and female, over the age of 16 years, with a full or one day Speedway Australia competition licence.
- 9.17.2 No consumption of alcohol less than 12 hours before said event. Anybody found intoxicated will be banned from the current and any future Demolition Derbies. No drinking of alcohol in the pits until the completion of the race meeting.
- 9.17.3 This Demo Derby is FORWARD only.
- 9.17.4 The event is started 2 to 4 wide with each car touching the car in front nose to tail when the YELLOW light is turned to GREEN
- 9.17.5 In the event of a yellow light being shown cars are to move under caution to the start line to restart 2 to 4 wide with each car touching the car in front nose to tail when the YELLOW/RED light is turned to GREEN.
- 9.17.6 The Racing Officials may at any time change the lights back to RED in the event of an accident or fire. All action must cease immediately when the RED light is on.
- 9.17.7 Crash helmets, neck braces (mandatory) and seat belts must be of an approved type and be worn at all times.
- 9.17.8 Competitors must be dressed from head to toe – no exposed skin. No Nylon or synthetic clothing allowed. Cotton drill overalls or better is strongly advised and work boots must be worn. NO THONGS, SHORTS, T-SHIRTS ARE ALLOWED.
- 9.17.9 Uniforms should be clean and free from oil, grease and petrol.
- 9.17.10 Any cars immobilized for longer than one minute will be deemed to be out of the event
- 9.17.11 Any cars deemed by racing officials not to be partaking in the demolition derby will be automatically disqualified.
- 9.17.12 Driver's using the infield grass area will be disqualified.
- 9.17.13 Any driver's door deemed to be hit on purpose by a fellow competitor; the offending driver will be instantly disqualified.
- 9.17.14 On receipt of paid entry, a number will be allocated.
- 9.17.15 Decision of Judges, Referees and Scrutineers are final. No protest will be considered.
- 9.17.16 Management has the right to refuse the entry of any driver without reason.

## 10.1. VINTAGE DEMONSTRATION RULES

10.1.1. No forming up on track

10.1.2. Cars must be evenly spaced before commencement of demonstration.

10.1.3. NO RACING ALLOWED.

10.1.4. Maximum of ten (10) cars on track at any time.

10.1.5. Racing seats must be professionally manufactured.

10.1.6. Commercially manufactured containment seats are recommended.

10.1.7. All driver safety equipment including seat belts, driver attire, arm restraint/window net requirements and helmets must comply to section 16 of the Speedway Australia Racing Rules and Regulations.

10.1.8. All caged vehicles must have a minimum of 55mm head height clearance to the top side of roll cage.

10.1.9. All vehicles participating in on track activities must be scrutineered prior to the event.

10.1.10. Raceivers (one way communication) must be used in all on track demonstrations by all participants.

10.1.11. All on track passing must be made only when safe to do so, and on the outside of the slower vehicle.

10.1.12. Transponders are not permitted.

10.1.13. All Speedway Australia Racing Rules and Regulations must be always followed. Penalties and sanctions do apply to all license holders.

10.1.14. Speedway Australia Racing Rules and Regulations section 4.1 regarding racing flags and lights must be followed for all on track activities.

10.1.15. Vehicles who participate in vintage demonstration must be a minimum of 30 years of age from their original manufacture date and keep must obtain the original construction and appearance where safe.

## 11.1. SAFETY REQUIREMENTS

- 11.1.1. All competitors will wear long sleeve shirts, long trousers and covered shoes.
- 11.1.2. **No thongs, shorts or T-shirts allowed** and no synthetic or nylon clothing to be worn.
- 11.1.3. Seat belts must be worn and properly adjusted during competition.
- 11.1.4. Helmets can be full face or open face and must meet one of the following standards:  
AS/NZS 1698, ECE 22-05, SFI: 31.1 or 41.1  
FIA: 8858-2010, 8859-2015 or 8860-2010  
Snell: SA2010, SA2015, SA2020, M2010, M2015 or SAH2010
- 11.1.5. Safety barriers must be provided for Racing Officials, Marshals and also cars held in staging area near burnout pad.
- 11.1.6. No Marshals or photographers are to be closer than 6 metres to a vehicle when competing on burn out pad.
- 11.1.7. No Marshal or photographer is allowed to stand directly in the path of a vehicle conducting a stationary burnout.
- 11.1.8. Driver and passenger must keep their torso within the confines of the vehicle. The passenger must remain in a position to be restrained by the seatbelt.
- 11.1.9. Qualified First Aid personnel must be in attendance.
- 11.1.10. Firefighting equipment and personnel trained in its use must be in attendance.

## 11.2. DRIVERS

- 11.2.1. No one under the age of 16 years (under 17 years in NSW) shall ride in, drive, or be in charge, of any motor vehicle during the conduct of the event.

## 11.3. DRUGS AND ALCOHOL

- 11.3.1. Drivers may be required to submit to an alcohol and/or drug test before the event and pit crew may also be tested at random.
- 11.3.2. No consumption of alcohol less than 12 hours before event. Anybody found intoxicated will be banned from the current event and any further events at the venue.
- 11.3.3. No drinking of alcohol in the pits until the completion of the meeting.

## **11.4. VEHICLES**

- 11.4.1. The driver's seating position must have a securely mounted and approved seat belt fitted.
- 11.4.2. All doors must have secure locking mechanisms.
- 11.4.3. The battery must be securely fastened.
- 11.4.4. The engine and underbody must be free from any oil or coolant leaks.
- 11.4.5. A minimum 600mm coolant overflow tank/ bottle must be held securely in place.
- 11.4.6. Fuel cells/ tanks and batteries must be isolated from the cabin area.
- 11.4.7. No liquid/ fluids to run through the cabin area unless fully enclosed in metal housing and approved by the scrutineer.
- 11.4.8. No sprays to be used anywhere on the vehicle, including, but not limited to tyres, radiators or intercoolers.
- 11.4.9. Blower belt guard, approved restraint system and aluminium shear mounting studs are required for all out of bonnet superchargers.
- 11.4.10. Mechanical fuel injection must have fuel shut-off that is operational from the driver's compartment.
- 11.4.11. A 4 litre engine oil puke tank minimum.
- 11.4.12. NITROUS REGULATIONS- the following safety rules apply for all vehicles using nitrous oxide at burnout events.
  - (a) Bottles must be mounted outside of the engine compartment. A bottle located inside the driver compartment must be mounted with metal brackets secured to a structural point of the body, vented outside of the driver's compartment to the atmosphere.
  - (b) Bottles must be upright or semi-upright, inverted bottles are not permitted.
  - (c) Bottles must be equipped with on/off taps.
  - (d) Bottles must be purpose built for use of nitrous oxide.
  - (e) All bottles must use two supporting brackets locked with the supplied nut and bolt.
  - (f) Nitrous lines must be outside of the driver's compartment, except where the bottle is mounted in the driver's compartment as near as possible to the bottle outlet.
  - (g) Where lines pass the converter or flywheel area, they must be encased in a minimum of 3mm (1/8 inch) thickness steel tubing.
  - (h) High pressure rated hose minimum 1500PSI is required, and a sintered bronze filter, fit for purpose, must be fitted in the gas supply line.
  - (i) Both solenoids must operate from common switch and the system must be capable of being switched off by three means
    - 1. When throttle is closed,
    - 2. By a special arming switch that provides power to the solenoids,
    - 3. Through the normal ignition switch).

- (j) All vehicles using nitrous oxide must display special markers located on the outside of the vehicle, in the area where the supply bottle is located and in the top left corner of the front windscreen. The marker shall be a yellow diamond, with n20 printed in black letters. These are available from ANDRA.
  - (k) A prominent blue warning light must indicate when the system is armed and be in full view from outside the vehicle by track and safety staff.
- 11.4.13 The fuel tank, if not original, is to be of a professional construction standard, or fuel cell type and securely mounted.
  - 11.4.14 Scatter shields to be fitted to all modified vehicles fitted with manual transmission.
  - 11.4.15 Bonnets must be fitted, and front mudguards should be fitted.
  - 11.4.16 No fuel or oil to be placed on wheels, either by manual or mechanical application.
  - 11.4.17 All wheels must have all wheel nuts fitted and secured.
  - 11.4.18 All wheel weights must be removed from drive wheels.
  - 11.4.19 No dress rims or hubcaps to be fitted.
  - 11.4.20 Modified floor pan/ fire wall and tunnel to be inspected by scrutineers for approval.
  - 11.4.21 A minimum tread depth should apply to drive tyres, depth can be set by organisers.

## **11.5 PIT AREA/INFIELD**

- 11.5.1 No person under the age of 16 years (under 17 years in NSW) will be permitted in the infield area during the conduct of an event.
- 11.5.2 The maximum speed of vehicles in the pit area is 15kph.
- 11.5.3 Burn outs are not permitted anywhere within the pit area or around the event complex or on any transporter.

## **11.6 BURNOUT PAD**

- 11.6.1 Pad should be level concrete.

## **11.7 COMPETITION RULES**

- 11.7.1 Any competing vehicle failing to keep within the defined pad area is either automatically disqualified or penalised points as determined by the promoter/organiser.
- 11.7.2 Authority of track Marshals to stop a competitor include fire, dropping fluids or debris onto the pad including oil or coolant, dropping glass or plastic from broken headlights/ lenses etc., dangerous driving, static burnout (burnout must be done whilst moving), not performing a burnout (driving in circles), exceeding the time limit.
- 11.7.3 Ignoring a Marshals direction to stop may result in loss of points or disqualification.

#### 11.7.4 BURNOUT CLASSES

While every effort will be made to cater for all entrants, event organisers have the discretion to appropriately assign entrants to nominated classes.

- (a) Pro Class
  - Engine- aftermarket supercharged, turbocharged, nitrous oxide
  - Fuel- petrol, E85, Ethanol or Methanol
- (b) Open Class
  - Engine- naturally aspirated or standard OEM supercharged/ turbocharged (i.e. Factory standard XR turbo or I67)
  - Fuel- (NITROUS OXIDE NOT PERMITTED) Petrol, E85, Ethanol or Methanol
- (c) 6 Cylinder Class
  - Engine- Naturally aspirated 4 or 6 cylinder
  - Fuel- (NITROUS OXIDE NOT PERMITTED) Petrol, E85, Ethanol or Methanol

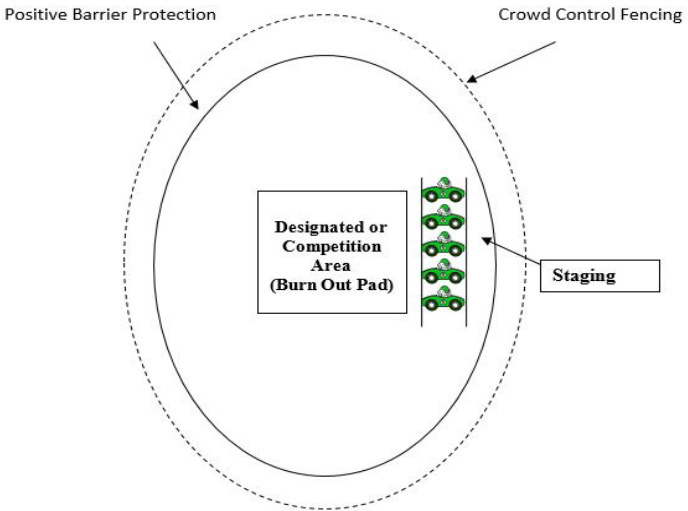

## **12.1 Appeal Form**

This form is to be used by any Licence Holder who wishes to appeal against a penalty imposed by a Chief Steward upon him or her in an Infringement Notice of otherwise, as per Rule 8.1.1.

## **12.2 Request for Disciplinary Tribunal**

This form is to be used by any Licence Holder who wishes to lodge a charge of misconduct, in accordance with Rule 7.5.3.

## **12.3 Request for Speedway Appeal Tribunal**

This form is to be used by any Licence Holder who wishes to appeal against a decision of a Disciplinary Tribunal, if the penalty handed down includes a penalty as per Rule 8.3.1. This form is also to be used by any Licence Holder who wishes to appeal against a penalty set down by Speedway Australia under Rule 7.6.

## **Chief Steward Report**

Please refer to [www.speedwayaustralia.org](http://www.speedwayaustralia.org) for the most up to date paper Chief Steward's Report Form.

The online Chief Stewards form can be completed at [www.speedwayaustralia.org/officials](http://www.speedwayaustralia.org/officials)

## 12.1 APPEAL FORM

### NOTE:

- a) An appeal may be lodged by a Race Car Owner, Driver, Marshal or Racing Official against a penalty imposed by a Chief Steward upon them to the Disciplinary Tribunal.
- b) The procedure for instituting an appeal is to lodge this form with the Drivers' Representative, Chief Steward or Host club/Division within 24 hours of being informed of the Chief Steward decision together with an appeal fee of \$500 to be paid to the Host Club (unless an Infringement Notice is only received on a day after the relevant Race Meeting, in which case this appeal form must be lodged within 48 hours to the Host Club).
- c) The appeal is to be heard immediately after the last Race of the Race Meeting during which the appeal arose and shall not operate as a stay of the decision of the Chief Steward.
- d) It is the responsibility of the Appellant to provide to the hearing, any witnesses or evidence he/she may choose to present (which may or may not be allowed by the Disciplinary Tribunal in accordance with rule 8.4.1).
- e) The decision of the Disciplinary Tribunal shall be final and an appeal shall only be allowed in accordance with rule.
- f) The finality of the appeal must be acknowledged by all.

**Date** \_\_\_\_\_

**Venue** \_\_\_\_\_

**Race No.** \_\_\_\_\_

**Race Title** \_\_\_\_\_

**APPEAL DETAILS IN FULL**

---

---

---

---

---

---

---

---

---

---

---

Declaration:

I, \_\_\_\_\_ the person making this appeal, hereby acknowledge that the decision of the Disciplinary Tribunal shall be final, and (other than in accordance with rule 8.3) there shall be no further appeal or recourse to any court.

**Signature of Appellant/Defendant:**

---

Date: \_\_\_\_\_ / \_\_\_\_\_ /20 \_\_\_\_\_

**Signature of Receiving Officer:**

---

Position of receiver:

---

Time of Lodgement \_\_\_\_\_

## 12.2 REQUEST FOR DISCIPLINARY TRIBUNAL

### Details of the person making the charge

Name \_\_\_\_\_

Position \_\_\_\_\_

Licence No. \_\_\_\_\_

Phone No. \_\_\_\_\_

Address \_\_\_\_\_

\_\_\_\_\_

Signed \_\_\_\_\_

Date \_\_\_\_\_

Request for formation of Disciplinary Tribunal, under rule 7.5 (Misconduct at a race meeting) to hear following charge:

1. Nature of Charge

\_\_\_\_\_

2. Against Whom

\_\_\_\_\_

3. Date of Race Meeting

\_\_\_\_\_

4. Speedway Venue

\_\_\_\_\_



## 12.3 REQUEST FOR SPEEDWAY APPEAL TRIBUNAL

### Details of the person making the charge

Name \_\_\_\_\_

Position \_\_\_\_\_

Licence No. \_\_\_\_\_

Phone No. \_\_\_\_\_

Address \_\_\_\_\_

\_\_\_\_\_

Signed \_\_\_\_\_

Date \_\_\_\_\_

Request the Speedway Appeal Tribunal to hear my appeal, under rule 8.3, against the decision of a Disciplinary Tribunal or decision of Speedway Australia

### 1. Nature of Appeal

- The severity of the penalty.
- Error(s) in the application and/or interpretation of the rule(s).
- Natural justice being denied.

Other: \_\_\_\_\_

### 2. Against a decision made by:

- A Disciplinary Tribunal Hearing held on \_\_\_\_\_
- Speedway Australia

**3. Further Detail as to reason of appeal: (Set out facts)**

---

---

---

---

---

---

---

---

---

---

I, \_\_\_\_\_ the person making this appeal, hereby acknowledge that the decision of the Speedway Appeal Tribunal shall be final, and there shall be no further appeal or recourse to any court.

Signature of Appellant/Defendant \_\_\_\_\_

Date \_\_\_\_\_

Signature of Receiving Officer \_\_\_\_\_

Position \_\_\_\_\_

Time of Lodgement \_\_\_\_\_

**Office use only**

Date received .....

Office Signature .....

Fee received.      Yes      No

## 13.1 PENALTY GUIDELINES

Please refer to **Appendix 8 Penalties Matrix** for information and guidelines on appropriate penalties for rule breaches.

OR

Click [HERE](#) to jump to the Penalty Matrix in Appendix 8

The minimum safety standards listed in this section are compulsory.

The definition of Licence category is available from the website ([www.speedwayaustralia.org](http://www.speedwayaustralia.org)) under "Safety".

All items of Safety Apparel must meet the relevant standard shown below and this standard must be clearly identified on the item.

## SAMPLE IDENTIFICATION STICKERS – HELMETS

### SNELL RATED HELMETS



### SFI RATED HELMETS



### FIA RATED HELMETS



### EUROPEAN STANDARD HELMET (ECE 22.05)

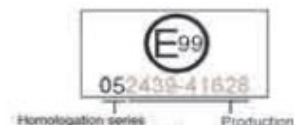

The ECE mark also consists of a circle surrounding the letter E followed by the distinguishing number of the country which has granted approval. The 05 denotes compliance with ECE 22.05. **(European Standard helmets are only permitted for Vintage/Classic & Extraneous divisions)**

## SAMPLE IDENTIFICATION LABELS – APPAREL

### SFI RATED APPAREL EXAMPLES – SUITS



### SFI RATED APPAREL EXAMPLES –

#### Undergarments, balaclava, shoes, socks & gloves

 <b>Undergarments</b>	 <b>Shoes</b>
 <b>Balaclava</b>	 <b>Arm Restraints</b>
 <b>Horse Collar</b>	

### FIA RATED APPAREL EXAMPLES – SUITS



### FIA RATED APPAREL EXAMPLES –

#### Undergarments, balaclava, socks, shoes & gloves

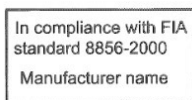

**(pre-2016)**

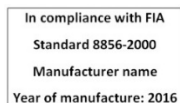

**(2016 onwards)**

#### The newest Standard FIA 8856-2018 for suits/underwear etc.

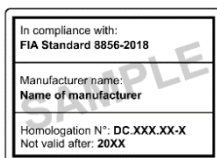

## 14.1 SEATBELTS

All **speedway divisions including Vintage/Classic** must be fitted with a safety harness/seat belt of the lever latch style, which must be certified by an authoritative body (such as SFI) and must conform to all of their policies including fitment/**installation**, care/maintenance and replacement period.

**(SKAA Karts and Extraneous divisions such as Demo Derby, Burnouts etc are excluded. Refer to Rules 9.6.3 & 9.16.23 for Demo Derby, and 11.1.3 for Burnouts.)**

See your division's specification documentation for any possible additional requirements to this standard.



SFI labels prior to 2017



Current SFI labels

## SEATBELT HANDY HINTS

### SFI INSTALLATION GUIDE FOR UPRIGHT SEATING

DOWNLOAD [HERE](#)

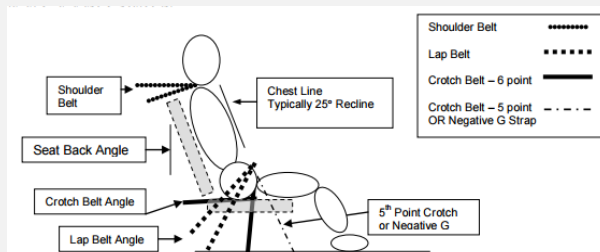

## APPLICABLE LICENCE CATEGORIES

**AA** *All Divisions except SKAA Karts*

**A** *All Open Wheeled Divisions*

**SSA** *Super Sedans*

**JD** *Junior Formula 500's*

### 15.1. Race Suit

Minimum standard of a 1 piece complying with either SFI 3.2A/5, FIA 8856-2000, FIA 8856-2018 or a higher standard apparel.

### 15.2. Boots

Comply with SFI 3.3, FIA 8856-2000 or FIA 8856-2018. Socks must comply with SFI 3.3, FIA 8856-2000 or FIA 8856-2018.

### 15.3. Arm Restraints/Window Nets

Arm restraints must be worn in all classes where a window net is not fitted. Must comply with SFI 3.3 or FIA. Where a window net is used, it must comply with SFI 27.1 or FIA J253.11 and comply with expiry dates/replacement periods.

### 15.4. Balaclavas

Comply with SFI 3.3, FIA 8856-2000 or FIA 8856-2018 and must be worn.

### 15.5. Gloves

Comply with SFI 3.3, FIA 8856-2000 or FIA 8856-2018. It is recommended they are the Gauntlet style glove and must not be modified in any way.

### 15.6. Underwear

Must be worn and comply with SFI 3.3, FIA 8856-2000 or FIA 8856-2018, must be long sleeved, long legged and must have a neck collar. Drivers must only wear cotton under-garments (e.g. no synthetic boxer shorts), and no underwires on bras. No synthetic attire & no jewellery to be worn by a competitor whilst competing.

### 15.7. Helmets

Full faced and comply with one of the following:-

- 1) **Snell SA2025 (to be introduced October 1<sup>st</sup> 2025)**
- 2) Snell SA2020
- 3) Snell SA2015 **(Please note all Snell SA2015 Standard Helmets cannot be used after July 1<sup>st</sup> 2026)**
- 4) FIA 8858-2010
- 5) FIA 8859-2015
- 6) FIA 8860-2010
- 7) **FIA 8860-2018**

### 15.8. Head and Neck Restraint

Meet FIA and/or SFI 38.1 Standard and must be worn. (A horse collar is optional when wearing a Head and Neck Restraint).

## APPLICABLE LICENCE CATEGORIES

- A** *All Sedan Divisions*  
**SSA** *All Divisions except Super Sedans*  
**B** *All Divisions*  
**JD** *Junior Competitors except Jr F500's*  
**V** *Vintage*

### 16.1. Race Suit

Minimum standard of a 1 piece complying with either SFI 3.2A/1, FIA 8856-2000, FIA 8856-2018 or a higher standard of apparel.

### 16.2. Boots

Comply with SFI 3.3, FIA 8856-2000 or FIA 8856-2018. Socks must comply with SFI 3.3, FIA 8856-2000 or FIA 8856-2018.

### 16.3. Balaclavas

Comply with SFI 3.3, FIA 8856-2000 or FIA 8856-2018 and must be worn

### 16.4. Gloves

Comply with SFI 3.3, FIA 8856-2000 or FIA 8856-2018. It is recommended they are the Gauntlet style glove, and they must not be modified in any way.

### 16.5. Underwear

Must be worn and comply with SFI 3.3, FIA 8856-2000 or FIA 8856-2018, must be long sleeved, long legged and must have a neck collar. Drivers must only wear cotton under-garments (e.g., no synthetic boxer shorts), and no under wires on bras. No synthetic attire and no jewellery to be worn by a competitor whilst competing.

### 16.6. Helmets

Full faced and comply with one of the following:-

- 1) **Snell SA2025 (to be introduced October 1<sup>st</sup> 2025)**
- 2) Snell SA2020
- 3) Snell SA2015 **(Please note all Snell SA2015 Standard Helmets cannot be used after July 1<sup>st</sup> 2026)**
- 4) FIA 8858-2010
- 5) FIA 8859-2015
- 6) FIA 8860-2010
- 7) **FIA 8860-2018**
- 8) **For Vintage/Classic & Extraneous Divisions only AS/NZS1698:2006 or UN ECE 22.05 standard. Must be no older than 5 years from manufacturer date.**

- 9) For JD (Junior Divisions) only, the following helmets are also approved for use.

SFI 24.1

**CMR2016\***

**CMS2016\***

(\*Please note all CMR2016 and CMS2016 standard helmets cannot be used after 30 June 2025.

These helmets are also not suitable to mount a Head & Neck restraint to)

#### **16.7. Horse Collar**

Compulsory if Driver is not using a Head and Neck Restraint, except Vintage uncaged cars.

Must comply with SFI 3.3.

#### **16.8. Head and Neck Restraint**

Recommended but not mandatory. If worn a Head and Neck Restraint must conform with FIA or SFI 38.1.

**For Vintage/Classic & Extraneous divisions:**

An AS/NZS 1698:2006 or UN ECE 22.05 helmet must not be modified in any way. Only a Snell or FIA helmet can be modified to wear a Head and Neck restraint device.

#### **16.9 Arm Restraints/Window Nets**

Arm restraints must be worn in all classes where a window net is not fitted. Must comply with SFI 3.3 or FIA. Where a window net is used, it must comply with SFI 27.1 or FIA J253.11 and comply with expiry dates/replacement periods.

Please note that SFI Spec 38.1 Head & Neck restraints must have an in-date compliance sticker on them. The SFI 38.1 Spec requires them to be re-certified every five years. Competitors and officials please take time to check the dates on all Head and Neck Restraints to ensure compliance with these rules.

#### **HANS Device Recertification**

Revolution Racegear

[www.revolutionracegear.com.au](http://www.revolutionracegear.com.au)

#### **Safety Solutions / Simpson Hybrid + variants & R3 Frontal Head Restraints**

Simpson Safety Equipment Australia

[www.simpsonraceproducts.com.au](http://www.simpsonraceproducts.com.au)

## APPLICABLE LICENCE CATEGORIES

### **K SKAA Karts incl Juniors**

#### **17.1. Drivers Suits**

Drivers must wear abrasive resistant overalls (to the satisfaction of the Scrutineer). No press-studs are allowed, and disposable type overalls are not acceptable.

#### **17.2. Boots**

Approved karting boots should be fire resistant (i.e. nomex woollen etc).

#### **17.3. Gloves**

Gloves are mandatory. Can comply with SFI 3.3, FIA 8856-2000 or FIA 8856-2018; Kart specific gloves and Motorcycle 'competition' gloves and mechanics type safety gloves, made of leather or other material of similar or greater durability, are acceptable. They must not be modified in any way. Gloves with integral knuckle protection are also recommended.

#### **17.4. Helmets**

Full faced with visor (no goggles), and comply with one of the following:-

- 1) **Snell SA2025 (to be introduced October 1<sup>st</sup> 2025)**
- 2) Snell SA2020
- 3) Snell SA2015 **(Please note all Snell SA2015 Standard Helmets cannot be used after July 1<sup>st</sup> 2026)**
- 4) FIA 8858-2010
- 5) FIA 8859-2015
- 6) FIA 8860-2010
- 7) **FIA 8860-2018**

For JD (Junior Divisions) only, the following helmets are also approved for use.

- 8) SFI 24.1
- 9) CMR2016
- 10) CMS2016

#### **17.5. Head and Neck Restraint**

A Head and Neck Restraint is mandatory (Horse Collars cannot be used).

Any Head and Neck restraint worn must be a commercially produced Head and Neck restraint system which is manufactured specifically for Kart or Motocross competition.

## **APPLICABLE CLASSES: ALL SPRINTCARS INCL WINGLESS**

### **2.2 LICENCES**

- 2.2.16 The logbook is to accompany the Sprintcar at all times and shall be passed to the new owner on sale of the Sprintcar. Replacement of the book will be made when it is full or beyond reasonable use. Old logbooks will be returned to the issuing club.

### **4.4 PUSH STARTS**

- i. Each Race Car is allowed one push/engine start without penalty before the initial Race start and following any red light/flag stoppage where the incident did not that Race Car, and the Race Car stopped due to the red light. For other push/engine starts, the Race Car will be required to go rear of field.
- ii. Any Race Car involved in a yellow light/flag stoppage, whether or not a contributing cause, and has become stationary, and for whatever reason requires a push/engine start, will be required to go rear of field in the restart.
- iii. Any Race Car involved in a red light/flag stoppage, whether or not a contributing cause, and has become stationary before the red light is shown, and for whatever reason requires a push/engine start, will be required to go rear of field in the restart.

### **4.6 STARTING OPTION**

- 4.6.2 The option given to a Driver under Rule 4.6.1 may be exercised after entering the track and upon initial form up. After this, there will be no change to any other starting positions.

### **4.9 PASSING**

- 4.9.4 If it is considered a driver has gained a position or advantage by passing or driving on the infield (anything more than the left-hand front wheel under the pole line), the driver will be put back 2 positions. This will apply to each Sprintcar passed and will be applied at the first available opportunity, i.e. race stoppage or on final race results.

#### **4.13 SINGLE FILE RESTARTS**

- 4.13.6 Any car that passes beneath the cone, hits the cone or passes another car before reaching the cone will be put back 2 positions. The race will continue and the driver will be shown the rule infringement flag and the penalty applied during a subsequent yellow/red light stoppage or at the end of the event.
- 4.13.7 Other than the first lap of a Race, Drivers unable to make a previous start, may return to the rear of the field provided that a complete racing lap has not been recorded since their withdrawal.
- 4.13.9 Any car with a flat tyre, except LHF must go rear of field at any yellow/red light stoppage. However, the driver will be shown the mechanical defect flag at the earliest opportunity if the car is deemed to be unsafe at the restart.

Any tyre may be changed on a Red Light or Yellow Light on the first lap of a main event. All work must be carried out in the work area and within the given time limit. Once any tyre has been changed the car will restart ROF.

#### **4.20 LAPPED CARS**

- a) In any restart, **any running Sprintcar at the time of the stoppage, one or more laps down will be credited one lap, placing them in the same running order prior to the stoppage.** Lapped Sprintcars are to take their positions as per the last recorded lap in order of placing behind those Sprintcars on the current lap.

#### **4.26 WORKING ON CARS**

- a) During an open red light/flag stoppage, Pit Crews Members may work on a Race Car, but on the Infield at designated area only. The Driver may get out of the Race Car if necessary. A wheel may be removed and replaced to change the offset or to allow for repairs, but only after notifying a Racing Official or Marshal so that it can be verified that the same wheel is put back on.

#### **4.28 REFUELLING**

- a) On track or Infield refuelling is only permitted during a red light/flag stoppage. Before refuelling, fire-fighters must be alerted, the engine must be switched off and extreme caution must be exercised to avoid spillages.

#### **4.29 SUBSTITUTE CARS**

- a) If a Sprintcar/Wingless Sprint Driver uses a substitute Race Car for time trials, he may use a substitute Race Car but time trial from last position and only able to qualify as high as position 11.
- b) When a multi-day/night Race Meeting is conducted, Sprintcar/Wingless Sprint Drivers may change chassis after each day/night's racing has been concluded and retain their points.

#### **7.8 PROTESTS**

- a) No driver is allowed to race under protest. All protests/appeals for disqualification shall be heard after the race meeting is completed, not during. Any driver stopping on the track to protest will be disqualified from the race.

#### **7.9 TECHNICAL**

- a) Engines will be checked at the completion of all State Championships and sanctioned Events and may be checked at any other time by Racing Officials.
- b) Sealed engines need not be rechecked unless specified in the entry conditions for that Event with the exception of Australian and State Titles.
- c) When engines are checked, it will be with an approved engine capacity checker or similar operated per the SCCA procedure.
- d) If an engine is measured with an SCCA approved instrument and found not to comply with the vehicle specifications, the Race Car Owner/Driver will be given the opportunity to remove the heads within a time limit of one hour.
- e) The placegetters in all sanctioned Events, State and Australian Titles to have their fuel checked for illegal additives.
- f) The width of wings will be checked on all Sprintcars after all sanctioned Events. Penalty for wing infringement will be disqualification for the Driver from that Race.
- g) Any Driver and Race Car Owner that prescribes the use of any engine, car or other component which offends against the published specifications, uses traction control, uses illegal fuel or additives, refuses to have his/her engine checked, damages or destroys SCCA property will be disqualified from the Race Meeting and will be suspended for a minimum of nine months to a maximum of 12 months from that date.

### SPEEDCAR RULE VARIATIONS

#### 4.4 PUSH STARTS

- (a) Each Race Car is allowed one push/engine start without penalty before the initial Race start and following any red light/flag stoppage where the incident did not involve that Race Car, and the Race Car stopped due to the red light. For other push/engine starts, the Race Car will be required to go rear of field.
- (b) Any Race Car involved in a yellow light/flag stoppage, whether or not a contributing cause, and has become stationary, and for whatever reason requires a push/engine start, will be required to go rear of field in the restart.
- (c) Any Race Car involved in a red light/flag stoppage, whether or not a contributing cause, and has become stationary before the red light is shown, and for whatever reason requires a push/engine start, will be required to go rear of field in the restart.

#### 4.20 LAPPED CARS

- a) In any restart, lapped Speedcars are to take their positions as per the last recorded lap in order of placing behind those Speedcars on the current lap.

#### 4.26 WORKING ON CARS

- a) During a red light/flag stoppage, Pit Crew Members may work on a Race Car, but on the Infield at designated area only. The Driver must remain in the Race Car at all times.
- b) Any Race Car that removes any wheel from the axle at any time will go rear of field at the restart.

## **SSA RULE VARIATIONS**

### **2.1 PRE RACE REQUIREMENTS**

- a) At a race meeting where drivers are required to nominate (e.g. State and National Titles) and the driver fails to appear at the event without withdrawing their nomination by the end of scrutineering, may be subject to an infringement notice.

### **3.2.3 WEIGHING OF CARS**

- a) Any driver who fails to present their race car to scales for weighing when directed to do so by a Racing Official will be disqualified from the event they have completed in immediately prior to the directive being given.
- b) Furthermore the driver is expected to go directly to the scales area without deviation once the directive is given and failure to do so will result in disqualification.

### **3.6 ROOF NUMBER PLATES**

- a) A roof number plate is mandatory for all Race Meetings. However, supplementary regulations may advise otherwise where transponders are being used to record laps.
- b) The roof number is a number issued for identification of a Race Car on Race day and may be distinct from the Race Car registration number. It shall be a metal plate 30cm square with a 5cm right angle fold at the bottom where 2 holes at 20cm centres shall be drilled to take 6 mm bolts.
- c) Number one is reserved for the current National and State Title holders with Australia 1 taking precedence at National Titles and the defending State Number 1 taking precedence at State Titles. All clubs recognise State title holders who wish to run Number 1 as their roof number, but home State title holders will take precedence at Club Meetings.
- d) The roof plate number shall be bolted to the roof of the vehicle at an angle from the left hand front to the right hand wheel arch or parallel with the side of the Race Car depending on lap scoring requirements. The number shall be painted using a black background and white numbers. 20, 30, 40, etc. shall not be used.

### **4.3 DUMMY GRID LINEUP**

4.3.1 Cars should take up their correct position on the dummy grid ready to race before entering the track. The Pit Marshall will cross cars over rows to close up any spaces as a result of scratching's.

### **4.5.1 STARTING**

The maximum field size in any heat race is 16 cars.

### **4.11 RACE INCIDENTS AND STOPPAGES**

4.11.5 Any Race Car stopping due to a red light, but not involved in the incident and not judged to be a contributing cause will be reinstated in the restarting order, regardless of whether a push start is required.

### **4.20 LAPPED CARS**

4.20.4 Lapped cars will be placed at the Rear of the Field at a race restart for heats and finals. They will be placed in the order that they were lapped or as directed by the Chief Steward.

### **4.23 COMPLETION OF A RACE**

4.23.3 The Chief Steward will declare a Race complete once the lead Race Car has passed the chequered flag. If the yellow lights/flags are shown after the lead Race Car crosses the Finish Line for an incident all the Race Cars receiving the chequered flag will finish in the order they crossed the Finish Line. The remaining Race Cars will be recorded as finishing in the order of their last completed lap not withstanding any penalties which could be applied by the Chief Steward.

4.23.7 For heat races, Race Cars that get the green flag to start the Race but are non-finishers will be eligible for points and/or prize money.

### **4.29 SUBSTITUTE CARS**

If a driver repairs their car, they can take up their position without penalty as per the original draw.

### **5.1 ACCREDITATION OF OFFICIALS**

- a) All SSA Officials must have undertaken and passed an accreditation program and be the holder of a current Working with Children (WWC) to be eligible to officiate at SSA sanctioned meetings.

### **5.5 SCRUTINEERING**

Rear of field does not apply.

### **6.4.5 SSA PROCEDURE FOR ALCOHOL TESTING**

Testing of SSA licenced drivers and officials to determine the presence of alcohol in their body by

analysis of their expired air, is appropriate and necessary for the safety of everyone involved in race meetings and events of Speedway Sedans Australia, it's state associations and its affiliated member clubs.

1. The testing for the presence of alcohol in the body is by the analysis of expired air. Testing will be conducted by a person trained and deemed competent to operate such equipment. Testing should be carried out prior to any Race but may be undertaken at any time during the Race Meeting.
2. An initial test will be undertaken and should this test return a positive reading a second test will be undertaken within twenty minutes under controlled conditions to confirm the initial positive test result. During this twenty minute period the person subject to the second test will not be permitted to take anything by mouth.
3. Any SSA Licence Holder detected with blood alcohol content above 0.0 milligrams per 210 litres of air will be declared unfit by the Chief Steward to participate further in the Race Meeting.
4. Any SSA Licence Holder returning a positive breath test result shall be excluded from taking any further part in the Race Meeting by the Chief Steward, surrender their SSA licence to such Steward and will be subjected to a penalty of up to 12 months suspension and a fine up to \$1000.
5. Any Licence Holder returning a test result above the required limit will be required by the Chief Steward to leave the Pits or any other restricted area. 5. Any SSA licence holder who refuses to provide a sample when requested to do so will be issued an infringement notice by the Chief Steward with a penalty of 10 years suspension and a \$5000 fine.

The process prior to the above and after are as per the existing rules in Section 6.

First offence disqualified from meeting, after that as per Section 6 of rule book.

## **7.8 PROTESTS**

- a) Any Driver who considers they have been aggrieved by the actions of another Driver during a Race may lodge a protest at the completion of a Race with the Chief Steward, within 2 minutes of the completion of the Race and before leaving the Race Track or Infield area
- b) Protests must be presented in person, but the Drivers Representative may be present.
- c) The Chief Steward will consider the case put by the Driver and may interview other Drivers or Officials where necessary to reach a decision. That decision will be given to the Drivers involved
- d) No fee is required nor is a form needed

- e) The Chief Steward may serve an Infringement Notice as a result of the protest.

## **7.9 TECHNICAL**

- a) If a race car is passed to compete by a scrutineer and another driver wishes to lodge an objection, that driver may lodge a technical appeal against the vehicle's eligibility or the engine eligibility.
- b) A Technical appeal can be lodged at any time during that race meeting. The appeal must state the specification(s) with which the car does not comply.
- c) The appeal form can be obtained from the Appeals Officer and it must be fully completed and returned to the respective official within 30 minutes with the appropriate fee.
- d) Appeal lodgement fee must accompany the completed appeal form. Appeal lodgement fee \$500, exception; engine eligibility which the appeal lodgement fee is \$5,000.
- e) If the appeal is upheld the lodgement fee is returned.
- f) If the appeal is dismissed the lodgement fee is retained, unless engine disassemble was required, in which case, the Appeal lodgement fee is given to the respondent to assist with re-assembly.

- 7.9.1 Where required and due to a Technical Infringement, a suspension of a SSA Car Registration may be imposed.

## **SECTION 14 - SAFETY APPAREL**

Any abuse of safety apparel will incur a penalty.

## RSA & AMCA RULE VARIATIONS

### 2.1 PRE-RACE REQUIREMENTS

- b) At a race meeting where drivers are required to nominate (e.g. State and National Titles) and the driver fails to appear at the event without withdrawing their nomination by the end of scrutineering, may be subject to an infringement notice.

### 3.4 MIRRORS

- 3.4.1 No rear or side view mirrors or highly polished panels intended for this purpose are permitted on any Race Car.

**Exception: RSA Fender Benders Division 1 & 2**

### 3.6 ROOF NUMBER PLATES

- e) A roof number plate is mandatory for all Race Meetings. However, supplementary regulations may advise otherwise where transponders are being used to record laps.
- f) The roof number is a number issued for identification of a Race Car on Race day and may be distinct from the Race Car registration number. It shall be a metal plate 30cm square with a 5cm right angle fold at the bottom where 2 holes at 20cm centres shall be drilled to take 6 mm bolts.
- g) Number one is reserved for the current National and State Title holders with Australia 1 taking precedence at National Titles and the defending State Number 1 taking precedence at State Titles. All clubs recognise State title holders who wish to run Number 1 as their roof number, but home State title holders will take precedence at Club Meetings.
- h) The roof plate number shall be bolted to the roof of the vehicle at an angle from the left hand front to the right hand wheel arch or parallel with the side of the Race Car depending on lap scoring requirements. The number shall be painted using a black background and white numbers. 20, 30, 40, etc. shall not be used.

#### **4.11 RACE INCIDENTS AND STOPPAGES**

- 4.11.5 Any Race Car stopping due to a red light, but not involved in the incident and not judged to be a contributing cause will be reinstated in the restarting order, regardless of whether a push start is required.

#### **4.29 SUBSTITUTE CARS**

If a driver repairs their car, they can take up their position without penalty as per the original draw.

#### **7.9 TECHNICAL**

- g) If a race car is passed to compete by a scrutineer and another driver wishes to lodge an objection, that driver may lodge a technical appeal against the vehicle's eligibility or the engine eligibility.
- h) A Technical appeal can be lodged at any time during that race meeting. The appeal must state the specification(s) with which the car does not comply.
- i) The appeal form can be obtained from the Appeals Officer and it must be fully completed and returned to the respective official within 30 minutes with the appropriate fee.
- j) Appeal lodgement fee must accompany the completed appeal form. Appeal lodgement fee \$500 exception; engine eligibility which the appeal lodgement fee is \$1,000.
- k) If the appeal is upheld the lodgement fee is returned.
- l) If the appeal is dismissed the lodgement fee is retained, unless engine disassemble was required, in which case, the Appeal lodgement fee is given to the respondent to assist with re-assembly.

#### **SECTION 14 - SAFETY APPAREL**

Any abuse of safety apparel will incur a penalty.

## LATE MODEL RULE VARIATIONS

### 4.12.5 COMPLETE RESTARTS: NATIONAL AND STATE TITLES ONLY

- a) At a yellow or red light stoppage before a lap has been completed of the final title deciding race, any car/s that sustains a flat tyre/s may be permitted to change it and restart in the race.
- b) Such car/s will go to the designated work area when instructed to do so by the Chief Steward and facilitate the change as quickly as possible.
- c) Other than pulling damaged body panels clear of tyres by hand NO OTHER WORK IS PERMITTED.
- d) Failure to facilitate the change in the designated work area or the carrying out of work more than permitted will see that car/s immediately disqualified from the race.
- e) When the tyre/s change is completed the car/s will rejoin at the rear of the field regardless of whether they were the cause of the stoppage or not.
- f) Any primary cause car will still go to the very rear of the field.
- g) The allowing of the tyre change can only be given by the Chief Steward and time constraints and curfews will be taken into account before he implements it.

## SKAA KART RULE VARIATIONS

### 2.2 LICENCES

Add ". . . Infringement Card/Drivers Log Book" at all references under 2.2.

e.g. 2.2.1 All Drivers participating in any Race Meeting must be in possession of a current Licence in the relevant category and Racing Division and an Infringement Card/Drivers Log Book that is free of unpaid fines and current suspensions. All Officials participating in any Race Meeting must be in possession of a current Licence in the relevant category.

### 3.1 RACE CAR REGISTRATIONS AND LOG BOOKS

Rules 3.1.1 to 3.1.3 are not relevant to SKAA Karts.

### 4.3 DUMMY GRID LINEUP

- 4.3.2 Any Driver whose Kart is not on the dummy grid and has notified the Pit Marshall, will be given two minutes to have their Kart ready at the pit gate. The two minute time commences when all Karts in the race are on the track and ready to be pushed off.

### 4.22 GETTING OUT OF CAR

- 4.22.1 Drivers are to assist push vehicles to prepare for restart, but must wait until quad bikes are in position. Not applicable for juniors. Failure to adhere to this rule will see penalties apply, as per Rule 4.22.2.

### 4.26 WORKING ON CARS

- 4.26 At National and State Championships and "Blue Ribbon Events" only, in a final, a Driver may change a fouled spark plug during the roll around before the baulk line is crossed and only prior to the start of the Race. This is to be done on the Infield and one mechanic only may assist. The Driver may re-join in

their original position with no penalty. Once the Race has commenced, no change is permitted.

#### **4.29 SUBSTITUTE CARS**

4.29.1 Chassis substitutions are permitted without penalty as a result of damage, providing it is re-scrutineered"

#### **5.5 SCRUTINEERING**

5.5.6 Rear of field does not apply.

#### **7.8 PROTESTS**

- a) Any Driver who considers they have been aggrieved by the actions of another Driver during a race may lodge a protest at the completion of a race with the Chief Steward via the Clerk of the Course/Race Director, within 5 minutes of the completion of the race.
- b) Protests must be presented to the Chief Steward in person, with the Drivers Representative present.
- c) The Chief Steward will consider the case put by the Driver and may interview other Drivers or officials where necessary to reach a decision. That decision will be given to the Drivers involved.
- d) A \$50.00 fee is payable, but no form is required. The fee shall be refunded to the driver should the protest be upheld, but forfeit if the protest is lost.
- e) The Chief Steward may serve an Infringement Notice as a result of the protest.

#### **DEFINITIONS**

##### **Baulk Line**

A specified point on the Race Track, set by the Chief Steward and/or the Promoter, and announced in the Drivers' Briefing, at which a Kart that has failed to start is to withdraw from the Event.

## FORMULA 500 RULE VARIATIONS

### 2.1 NOMINATIONS

- 2.1.2 (a) Late Nominations as per conditions stated on Entry Form.

### 4.3 DUMMY GRID LINEUP

- 4.3.1 Cars should take up their correct position on the dummy grid ready to race before entering the track. The Pit Marshall will cross cars over rows to close up any spaces as a result of scratchings. However once pushed off and on track, if a car is missing from a row then cars in that same row will move up and fill the gap.

#### 4.23.3 FINISH OF RACE

- a) To be classified as a finisher of any race, the competitor must pass the finish line/chequered flag under the cars own power without the assistance of others, with the driver seated in their correct position in the race car.

### 4.26 WORKING ON CARS

- 4.26.7 Once a competitor has entered the track, if their seat belt is unbuckled without the Steward's prior consent, that driver is to be disqualified from that event (heat/race), unless the driver undoes their belts for safety reasons, (e.g. tipped on side, fuel leaking, possible fire risk) and the driver can be ready to re-enter the race by the time the rest of the field is ready to resume the race.

### 4.29 SUBSTITUTE CARS

- 4.29.1 Formula 500 does not allow any substitute cars.

### 7.8 PROTESTS

- 7.8.1 RIGHT TO PROTEST - Any driver licensed under these

Regulations who may consider him/herself aggrieved by any act on the part of any other driver or any irregularity occurring during the course of a race in which he/she is or has been taking part shall be entitled to protest as set out in these rules.

- 7.8.2 Any driver wishing to protest to the Steward must approach the Drivers' Representative of the meeting with his/her Rule Book and indicating/showing the Drivers' Representative as to which Rule he/she wishes to use in regard to the protest.
- 7.8.3 **LODGING OF PROTESTS** - The intention to protest against any alleged irregularity at all occurring during the course of a race shall be signified **verbally** to an Official prior to leaving the race course.
- 7.8.4 The protest in writing shall be lodged with the steward within **30** minutes of the completion of the particular race, together with the requisite fee, \$250.00.
- 7.8.5 Nothing in this regulation shall have effect or prejudice the right of any officer, acting in his/her official capacity to take such action as he/she may deem proper in the circumstances.
- 7.8.6 **USE OF VIDEO EVIDENCE** - Use of Video evidence is permitted in the Protest and Appeal procedures if more than one camera angle is used.
- 7.8.7 **APPEALS** - Appeals as per Section 8 of the Speedway Australia Racing Rules & Regulations

## **16 SAFETY APPAREL**

- 16.9 **ARM RESTRAINTS** are compulsory and must comply to SFI or FIA Standards.

## **V8 DIRT MODIFIED RULE VARIATION**

### **4.20 LAPPED CARS**

- a) In any restart, lapped cars are to take their positions as per the last recorded lap in order of placing behind those cars on the current lap.

## LIGHTNING SPRINT RULE VARIATIONS

### 4.11 RACE INCIDENTS AND STOPPAGES

- 4.11.6 Any race car judged by the Chief Steward to be the absolute and sole cause of any stoppage will go to the very rear of field in the restart, regardless of whether the race car stopped and regardless of whether other race cars require a push start. All other race cars that come to a complete stop will also be sent to rear of field. They will line up in front of the race car/s deemed to have caused the incident in the order as directed by the Chief Steward.

### 4.13 SINGLE FILE RESTARTS

- 4.13.5 When the single file is correctly formed up and a start is imminent by instruction via the Chief Steward, the yellow lights will be switched off and flags withdrawn. The lead race car determines the speed of the start at a constant moderate pace. The lead race car then has the option of commencing the race from the middle of turns three and four but no sooner or to the cone marker at the start/finish but no later.

### 4.20 LAPPED CARS

- 4.20.1 When a race car receives the lapping flag the driver of that race car must expect to be lapped sometime within the next lap or soon after. The lapped race car must hold line, and, must not race or impede the lapping race car or cars. The lapping flag will continue to be shown to a driver on each lap that being lapped by another race car is likely.

## APPENDIX 8 – PENALTIES MATRIX

The information contained in the next pages summarises the penalties outlined in various sections of the rulebook. They are presented in rule number order.

Rule	Warning Flags	Loss of Two Positions	Rear of Field	Black Flag	Infringement Notice	Fine / Suspension
2.2.2 Driver does not have appropriate licence for Racing Division					No appropriate licence to compete	Disqualification from Race Meeting, \$1000 Fine, & 6-month licence suspension
2.2.2 (a) Racing Official not accredited appropriately						\$500 Fine
3.3.1 Failure to wear all approved safety equipment and protective clothing				Disqualified from the event where the driver was found to not be wearing all approved safety equipment and protective clothing	Failure to wear all approved safety equipment and protective clothing	First offence disqualified from event and fined \$500.  Subsequent offence disqualified from event, fined \$1000 and 3-month licence suspension
3.4.3 Communication Equipment			Non-Compliance with requirement to use one-way in-car communicators			

<b>Rule</b>	<b>Warning Flags</b>	<b>Loss of Two Positions</b>	<b>Rear of Field</b>	<b>Black Flag</b>	<b>Infringement Notice</b>	<b>Fine / Suspension</b>
3.4.4 Communication Equipment					Unauthorised use of communication equipment	Minimum 12-month licence suspension
3.5.3 Noise Control	Noise warning flag			Continuing to exceed maximum noise level	Failure to comply with black flag	Fine between \$300 and \$2,000, and/or 3 month to 2 year licence suspension. Also \$100 per lap and/or disqualified from race meeting
4.4.1 Push Starts			Second push start for Sprintcar or Speedcar following initial start of the race			
4.4.2 Push Starts	Mechanical Defect Flag					
4.5.1 Race Starts			Delays Race start by more than 2 minutes			
4.5.2 Race Starts					Passing pace car	\$100 Fine
4.5.8 Race Starts			Unable to time trial for heat starting position. ROF for all heat races.			

<b>Rule</b>	<b>Warning Flags</b>	<b>Loss of Two Positions</b>	<b>Rear of Field</b>	<b>Black Flag</b>	<b>Infringement Notice</b>	<b>Fine / Suspension</b>
4.7.1 Break Formation / Jump Start	First offence for breaking formation or jumping start from front row		Second offence for breaking formation or jumping start from front row			
4.7.2 Break Formation / Jump Start	Break formation or jump start within field (but Chief Steward wishes race to continue)	Penalty for each race car unfairly passed through breaking formation or jumping the start will be applied at next stoppage or end of the race				
4.8.2 Travelling at speed across infield				Travelling at speed on the infield will be considered dangerous driving as per Rule 4.8.3		
4.8.4 Reckless or Dangerous Driving				Deliberate, reckless or negligent contact with other cars or travelling at speed on infield	Serious deliberate, reckless or negligent contact with another race car	Maximum fine \$2,000 and/or maximum 2-year licence suspension

<b>Rule</b>	<b>Warning Flags</b>	<b>Loss of Two Positions</b>	<b>Rear of Field</b>	<b>Black Flag</b>	<b>Infringement Notice</b>	<b>Fine / Suspension</b>
4.9.3, 4.9.4 & 4.9.5 Passing (Making contact)	Careless driving during overtaking	Penalty for each race car passed by careless driving/making contact, applied at next stoppage or race end	Persistent careless driving/making contact, penalty applied at next stoppage or race end	Chief Steward discretion where required for excessive careless driving/making contact	Chief Steward discretion where required for excessive careless driving in accordance with Rule 4.8.3 also	Maximum fine \$2,000 and/or maximum 2-year licence suspension
4.9.4 and 4.9.5 Passing (using Infield)		Penalty for each race car passed by putting wheel on infield, applied at next stoppage or race end	Repeatedly passing on infield, penalty applied at next stoppage or race end		Chief Steward discretion where required for excessive careless driving in accordance with Rule 4.8.3 also	Maximum fine \$2,000 and/or maximum 2-year licence suspension
4.10.2 Track Re-entry	Careless race track re-entry		Reckless race track re-entry, penalty applied at next stoppage or race end	Dangerous race track re-entry	Dangerous race track re-entry at discretion of steward.	As per Rule 4.8.4 (Reckless or Dangerous Driving) Maximum fine \$2,000 and/or maximum 2-year licence suspension
4.11.2 Race Stoppage		Penalty for each race car passed while rolling around under yellow lights at Chief Steward discretion				

<b>Rule</b>	<b>Warning Flags</b>	<b>Loss of Two Positions</b>	<b>Rear of Field</b>	<b>Black Flag</b>	<b>Infringement Notice</b>	<b>Fine / Suspension</b>
4.11.4 Race Stoppage			Failing to stop on red light	Option to disqualify from race meeting	Failing to stop on red light – option of fine	Minimum \$100 Fine
4.11.6 and 4.11.7 Race Stoppage			Primary or contributing cause of Race stoppage			
4.11.8 Race Stoppage				Primary cause of two race stoppages		
4.11.11 Fail to Obey Chief Steward				Subject to disqualification	Subject to an infringement notice for failing to obey Chief Steward	Fine up to \$1000 and/or up to 12-month licence suspension
4.13.3 Single File Restarts	First refusal to accept restart position		Second refusal to accept restart position	Third refusal in any one race to accept restart position		
4.13.6 (a) Single File Restarts – overlapping or passing		Drives in part or beside another vehicle (overlaps) but does not gain a position. OR Two position per car passed if Race Car passes another car before the cone.				

<b>Rule</b>	<b>Warning Flags</b>	<b>Loss of Two Positions</b>	<b>Rear of Field</b>	<b>Black Flag</b>	<b>Infringement Notice</b>	<b>Fine / Suspension</b>
4.13.6 (b) & (c) Single File Restarts – passing on inside of cone or hitting cone		Passing on the inside of cone or hits the cone without dislodging it. Two position per car passed if a Race Car passes on inside of the cone and gains position	If a Race Car hits the cone and dislodges onto the track, causing a stoppage.			
4.13.9 Single File Restarts	Mechanical defect flag for any flat tyre					
4.14.1 and 4.14.3 Warning Flag	Driving in overly aggressive or careless manner		Second warning for continuing to drive in careless manner	At Chief Steward discretion		
4.15.4 Rear of Field				Driver refusing to go rear of field when directed		
4.17.2 Black Flag					Failure to comply with black flag	Minimum penalty of \$300 fine and 1-month licence suspension

<b>Rule</b>	<b>Warning Flags</b>	<b>Loss of Two Positions</b>	<b>Rear of Field</b>	<b>Black Flag</b>	<b>Infringement Notice</b>	<b>Fine / Suspension</b>
4.17.3 Black Flag					Failure to comply with black flag	Additional \$100 per lap and disqualification from Race Meeting for continuing to not comply with black flag to a maximum of a \$2,000 fine and 2-year licence suspension (inclusive of penalty in Rule 4.17.2).
4.19.1 Dropping of Debris			Car drops debris on race track which leads to race stoppage			
4.19.3 Dropping of Debris				Part of engine cover lost or damaged & compromises driver safety		
4.20.2 Lapped Car				Lapped car impeding lapping traffic		

<b>Rule</b>	<b>Warning Flags</b>	<b>Loss of Two Positions</b>	<b>Rear of Field</b>	<b>Black Flag</b>	<b>Infringement Notice</b>	<b>Fine / Suspension</b>
4.20.3 Lapped Race Cars	Slow moving damaged or disabled car shown mechanical defect flag – go to infield					
4.21 Purposely Stopping on Race Track				Driver purposely spun or stopped on race track to force a stoppage		
4.22.2 Getting out of Race Car				Driver) removes or undoes safety apparel while in confines of track without permission of Chief Steward  For a second offence, driver will be disqualified from the remainder of the Race Meeting		

<b>Rule</b>	<b>Warning Flags</b>	<b>Loss of Two Positions</b>	<b>Rear of Field</b>	<b>Black Flag</b>	<b>Infringement Notice</b>	<b>Fine / Suspension</b>
4.22.3 Getting out of Race Car				Driver gets out of race car to remonstrate or make defamatory gestures	Getting out of race car to remonstrate with Racing Officials or Marshals or other drivers	A minimum fine of \$500 up to a max fine of \$2,000, and/or up to maximum 12-month licence suspension
4.22.4 Failing to remain with car on infield					Failing to remain with race car on infield	Minimum \$100 fine and/or disqualified from the race meeting
4.25.1 and 4.25.2 Mechanical Defect	Cannot safely continue & shown Mechanical Defect Flag, must pull infield			Driver ignoring Mechanical Defect Flag	Failure to comply with black flag	Fine between \$300 and \$2,000, and/or 1-month to 2 year licence suspension, plus additional \$100 per lap and/or disqualified from race meeting
4.25.3 Mechanical Defect (Flat Tyre)	Mechanical defect flag for any flat tyre					

<b>Rule</b>	<b>Warning Flags</b>	<b>Loss of Two Positions</b>	<b>Rear of Field</b>	<b>Black Flag</b>	<b>Infringement Notice</b>	<b>Fine / Suspension</b>
4.26.3 Working on Race Cars			When work not completed in time, race car may re-join at subsequent restart if no further laps of race completed			
4.26.4 Working on Race Cars			Changing a wheel during red light/flag on first lap of a state or National Title or other agreed major event			
4.26.7 Working on Race Cars				Driver undoes safety apparel and gets out of Race Car		
Appendix 2 Speedcars, 4.26(b) Working on Race Cars			Speedcar removes wheel from any axle			
4.27.1 Unauthorised entry to Race Track (Any Pit Crew or other person)					Entry to race track without Chief Steward authority	Person subject to \$500 fine and if a Pit Crew, associated driver fined \$500 and/or disqualified from race meeting

<b>Rule</b>	<b>Warning Flags</b>	<b>Loss of Two Positions</b>	<b>Rear of Field</b>	<b>Black Flag</b>	<b>Infringement Notice</b>	<b>Fine / Suspension</b>
4.27.2 Unauthorised entry to Track					Subsequent unauthorised entry to race track	Person subject to 12-month licence suspension and driver fined \$1,000 and/or disqualified from race meeting
5.3.4 Driver Briefing			Driver (or agreed representative) failing to attend drivers briefing – penalty applies to all heat races only			
5.4.4 Driver Briefing			Driver (or agreed representative) failing to attend drivers briefing – penalty applies to heat races only			
5.6.4 Scrutineering			Any Race Cars that did not present for scrutineering at least 60 minutes prior to Race Meeting start time, at discretion of Chief Steward, will start at the rear of field for all heats.			

<b>Rule</b>	<b>Warning Flags</b>	<b>Loss of Two Positions</b>	<b>Rear of Field</b>	<b>Black Flag</b>	<b>Infringement Notice</b>	<b>Fine / Suspension</b>
5.6.6 Scrutineering			Driver entering infield to check race car serviceability and requires a push start			
6.1.7 Drug and Alcohol Policy					Refusal to provide sample for drug	Excluded from event, 10-year licence suspension and \$5,000 fine
6.2.4 Drug Testing Procedure					Positive result to drug test	Excluded from event and not allowed in any restricted areas and subject to penalties listed in 6.6
6.4.4 Possession of Alcohol					Possession or drinking of alcohol in restricted areas	Driver excluded from event and not allowed in restricted areas and subject to penalties listed in 6.6

<b>Rule</b>	<b>Warning Flags</b>	<b>Loss of Two Positions</b>	<b>Rear of Field</b>	<b>Black Flag</b>	<b>Infringement Notice</b>	<b>Fine / Suspension</b>
7.2.4, 7.2.5 & 7.2.6 Verbal and Physical Abuse					Verbal or physical assault, abuse or attempt to strike	Minimum fine of \$100 up to a maximum fine of \$5,000 and/or a maximum 2-year Suspension. Refer to Matrix in Rule 7.2.6 for more information.
7.5 & 7.6 Misconduct					Misconduct at a Race Meeting	A maximum fine of \$5,000 and/or maximum 10-year licence suspension (set by Tribunal and/or Speedway Australia)
7.9.2 Technical					Non-compliance with technical specifications	Maximum fine \$2,000 and/or maximum 2- year licence suspension



**NATIONAL  
INFORMATION**

**As of July 2025, these are the current Speedway Australia Committee of Management and Staff Members:**

## **COMMITTEE OF MANAGEMENT MEMBERS**

Mark Cooper – Chairperson  
Ryan Harris – Vice Chairperson  
Greg Lynd  
Mark Richards  
Darren Cassidy  
John Kelly  
Patrick Breinen



## GROUP PERSONAL INJURY INSURANCE

For the benefit of all Speedway Australia licence holders, Speedway Australia arranges through its appointed insurance brokers AJ Gallagher & Co (Gallagher), a comprehensive Group Personal Injury insurance policy underwritten by Liberty Specialty Markets Australia.

By purchasing this policy on a group purchasing basis, Speedway Australia is able to provide complimentary personal accident cover to its licence holders.

The policy cover summary and PDS is available to view on the Speedway website at [speedwayaustralia.org](http://speedwayaustralia.org) under the downloads tab.

We recommend you read and understand the cover provided and contact Gallagher directly on (08) 8171 8121 if you have any further queries.

**\*\*Licensed drivers intending to compete in Speedway Events overseas must contact Speedway Australia prior to travel for written approval from Speedway Australia for cover to apply.**

The Speedway Australia Public Liability Insurance Scheme is arranged by Arthur J Gallagher & Co (Gallagher) the appointed Insurance Broker to Speedway Australia.

Headquartered in the USA, Gallagher are one of the world's insurance brokers and risk consultants with offices in all Australian States and Territories. Gallagher's expertise in Sport and in particular Motorsport is extensive, providing broking services to most national motorsport governing bodies.

All tracks that choose to participate in the Speedway Australia scheme benefit with reduced premium costs. All participating tracks contribute to the policy according to their track rating and race categories permitted by Speedway Australia.

The main advantages of group buying over purchasing individual policies are;

- Group buying achieves costs savings.
- Cover is designed specifically for Speedway risks.

In addition to the cover provided, tracks are entitled to rain out or pre-event cancellation refund credits. Premiums are paid on a meeting to meeting basis without the need to pay a full annual premium in advance. In 2008, a Low Risk category was introduced to ease costs for smaller tracks who have low crowd attendances and less numbers of competitors.

If you would like to know more about Speedway Australia Public Liability Insurance, please contact Gallagher directly on (08) 8171 8121

Speedway Australia encourages participation in speedway at all levels, including junior level events.

As a Speedway competitor, you'll experience the thrill of being in the driver's seat at high speeds in intense competition. The cost of competing varies depending on the type of Speedway racing you would like to participate in – from varying licence costs to the cost of a car, travel and spare parts. Here are a few pointers to get you started in Speedway!

Speedway events are run on almost every weekend of the year, depending on which state you're in, and range from grass roots events to major events such as World Series Sprintcars.

Attending different types of Speedway racing events will help you work out which discipline of the sport you would like to become involved in.

Once you're ready to get involved, many clubs and tracks hold participation or "Come 'n' Try" days. Speedway Australia also offers One-Day Licences to competitors, so you can get out on the track without paying for a full season of racing. One-Day Licences are available for both junior and senior drivers.

## **BEFORE YOU START COMPETING**

To ensure that every Speedway competitor is fit and capable to compete, all competitors must be licensed. This means that they have applied to Speedway

Australia for a Speedway licence and have satisfied the licensing criteria by:

- Becoming a member of an association or club
- Applying for a Speedway Australia Licence
- Submitting a health statement
- Undertaking an approved medical examination
- Agreeing to abide by the Speedway Australia Drug & Alcohol Policy
- Agreeing to abide by the Speedway Australia Code of Conduct

For more information on upcoming events and getting involved in Speedway, contact Speedway Australia Head Office directly on (08) 8139 0777.

You can also find a Competitor Association or Track near you by visiting [www.speedwayaustralia.org](http://www.speedwayaustralia.org)

Speedway Australia encourages good sportsmanship at all levels of competition.

Here is a guide to Codes of Conduct for your association, club, track, drivers, Racing Officials, Marshals and parents. If you have any questions about the Code of Conduct, please contact Speedway Australia Head Office on (08) 8139 0777, or visit <https://www.playbytherules.net.au/> for advice.

### **Speedway Australia Encourages Sportsmanlike Conduct:**

- Always comply with the rules.
- Always compete to the best of your ability, with honour and integrity.
- Avoid arguing with Stewards, Scrutineers and Marshals. Most Stewards, Scrutineers and Marshals have volunteered their time and services to ensure your race runs smoothly and efficiently. Without their assistance the sport could not exist.
- Treat all competitors as you would like to be treated – do not interfere with, bully, intimidate or take advantage of any other participant. This includes using email or social media to bully or slander competitors.
- Avoid the use of intimidating, coarse or derogatory language.
- Place the safety and welfare of all participants above all else.
- Ensure the spirit of competition is maintained - An honest effort is as important as victory.
- Racing Officials and Marshals should be understanding and co-operative in the interpretation and application of rules and penalties.
- Racing Officials and Marshals should be impartial, consistent and objective at all times.
- Parents should encourage children to participate to the best of their ability - Focus upon the child's performance rather than the overall outcome of the event.
- If you see something you consider 'ugly parent syndrome' behaviour, visit [www.playbytherules.net.au](http://www.playbytherules.net.au) and help to solve the problem.

### **SPEEDWAY AUSTRALIA TRIBUNALS**

Speedway Australia expects all Licence holders to uphold the Code of Conduct and as such, treats allegations of poor conduct and bringing the sport of Speedway into disrepute very seriously. These matters may be referred to a disciplinary tribunal.

## SOCIAL MEDIA

Speedway Australia encourages participation in online social media in a positive manner. The accessible nature of the internet, however, can lend itself to the posting of threatening and derogatory material in the heat of the moment.

Once your thoughts and comments are published to the internet they are visible to the world - and they are permanent.

Speedway Australia takes all cases of threatening and derogatory behaviour seriously and will treat online matters as it would 'real world' bullying.

Breaching the Code of Conduct or bringing the sport of Speedway into disrepute online can lead to serious consequences, including tribunals, suspensions and the cancellation of the offender's Speedway Australia licence.

If you have questions about what constitutes acceptable content and online behaviour, please contact Speedway Australia on (08) 8139 0777.

Speedway Australia is committed to communicating effectively with its licence holders, tracks, promoters, divisional bodies and stakeholders in order to improve Speedway for all participants.

Our primary communication outlets are the official Speedway Australia suite of websites, Facebook and Instagram pages, as they are the most efficient platforms to instantly update the entire speedway community.

We also send a fortnightly newsletter (Speed eNews) to track and club administrators.

Links to all of these sites can also be found on the Speedway Australia App.

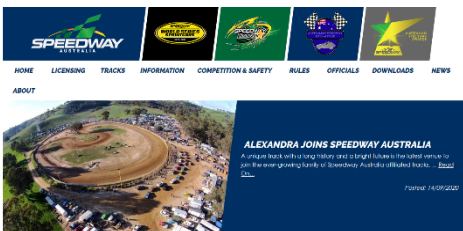
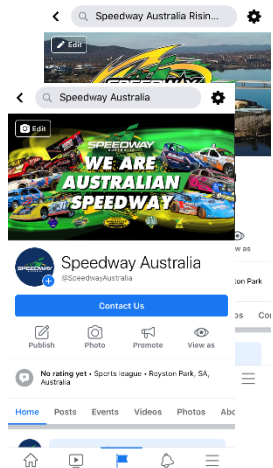
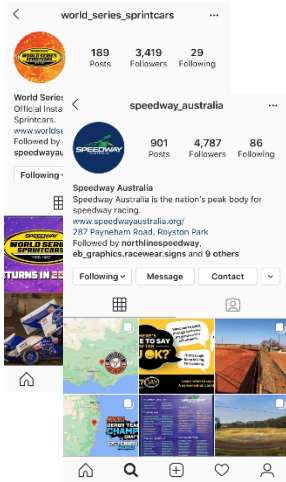

In 2011/12, Speedway Australia successfully launched an online licensing system aimed at making Speedway licence applications simpler and faster than ever before.

In 2019, the Speedway Australia app was launched, bringing licence cards onto your smartphone and reducing wait times with licences no longer having to be posted around the country.

Clubs have access to their own portal on the Speedway Australia Online Licensing System, enabling the club to manage their own membership base. The infrastructure also tracks suspensions and expired licences.

Speedway Australia have now phased out paper forms all together.

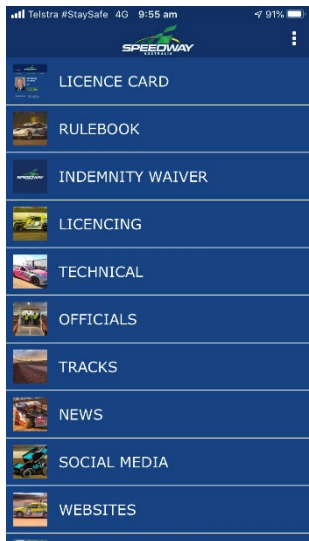

A Speedway Australia Day Licence is only available for competition for SSA, B, E, V, A Class Sedans and Super Sedans and Late Model licenced Racing Divisions. They are available for all divisions for practices.

A maximum of 2 Day Licences may be issued to a competitor per year, after which the competitor must apply for a full Speedway Australia Licence.

All Speedway Australia Day Licences include Personal Accident Injury Insurance Cover for the duration of the licence.

Licence Class	Licence Type	Price
AA	Driver	\$330
A	Driver	\$275
SSA	SSA Driver	\$240
B	Driver	\$235
JD	Junior Driver	\$120
JDOWK	Junior F500/SKAA Driver	\$150
JDJQMA	JQMA Driver	\$120
C	Mechanic / Pit Entry	\$140
D	Official – Steward & Scrutineer	\$30
D	Official – All other	\$30
E	Extraneous Events Competitor	\$155
V	Vintage Events Competitor	\$155
JM	Junior Mechanic	\$95
JO	Junior Official	\$30

Note: Applications lodged via paper forms in person, or via email incur an additional \$25 administration fee. A printed licence card is available for an additional \$20.

Licensing  
Club Administration Login  
Licence Categories  
Medical Standards

Contact Us:  
Ph: (08) 8139 0177  
Fax: (08) 8343 7977  
admin@speedwayaustralia.net.au

Office Location:  
28/ Maynard Road  
ROYSTON PARK SA 5070

Postal Address:  
PO Box 269  
STONEY SA 5046

## LICENCING

Speedway Australia is the leading Speedway licencer in Australia with over 12,000 licence holders nationwide.

### First Time, Renewal or Upgrade (Includes Media)

Please select the 'First Time Licence' if you haven't previously held a Speedway Australia licence. Select 'Renew a Licence' to update your current licence or click the 'Licence Upgrade' tab if you are transferring to a higher licence category.

**FIRST TIME  
LICENCE**

**RENEW A  
LICENCE**

**LICENCE  
UPGRADE**

### One Day Licences

Day licences are available for anyone looking to try their hand in the sport of Speedway. One Day Licences are available for all classes if used for a practice day event, but restrictions apply on some classes when the day licence is being used under racing conditions.

**ONE DAY  
LICENCES**

[www.speedwayaustralia.org](http://www.speedwayaustralia.org)

## WHAT ARE THEY?

A One Day Pit Licence can be purchased at the track's pit entry gate or via the Speedway Australia website/app and is available for anyone who does not have a current annual speedway licence.

The recipient of a One Day Pit Licence is granted personal accident insurance. Without either an annual Speedway Australia Licence or a One Day Pit Licence, you will not be protected by personal insurance in the event of an accident at the track.

## WHY DO I NEED IT?

All people in the pits, on the track, on the infield or in any other hot areas of a Speedway venue must have a licence and personal accident cover as per Speedway Australia policies. In the event of an incident or accident where you may be injured and/or incur medical costs, you will have personal accident insurance to cover you.

Mechanics and crew members that require pit entry at multiple events throughout the year can avoid completing a One Day Licence form every time by purchasing a Speedway Australia Mechanic/Pit Entry Licence for \$140 (valid for 12 months).

## WHAT HAPPENS IF I DON'T HAVE ONE?

You will not be covered by any personal accident insurance cover if you enter a pit area without any form of Licence (One Day or Annual). You may also be refused entry to the venue's pit area without a licence.

N.A.S.R. Incorporated (AS/134)  
 PO Box 209  
 STURGEON'S VA 5060  
 Phone: 080 823 9177 Fax: 080 8262 7977

  
 TAX INVOICE  
 AIN: 11 212 518 724

**Speedway Australia One-Day Pit Licence**

Licence Number: \_\_\_\_\_  
 Venue: \_\_\_\_\_  
 Event Date: \_\_\_\_\_  
 Applicant Name: \_\_\_\_\_ Car # \_\_\_\_\_  
 Address: \_\_\_\_\_  
 Phone: \_\_\_\_\_

I agree to be bound by the rules and regulations of any event at which I am to attend or participate ("the event") as well as the provisions and rules of N.A.S.R. Incorporated and any National or State Regulatory Bodies of the division in which I participate.

Applicant's Signature: \_\_\_\_\_  
 Issued by: \_\_\_\_\_  
 Issuing Officers Signature: \_\_\_\_\_

Fee payable: \$10.00 (GST inclusive)

Licence includes entitlement to personal accident insurance coverage on the event date stated above (no completion of single day event)

White Copie: Applicant Yellow Copie: Club/Track Green Copie: Speedway Australia

OR

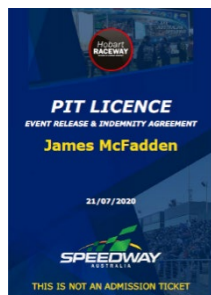

Speedway Australia joined the SFI Foundation in 2006 for the benefit of all Speedway Stakeholders in order to provide all divisions with the benefit of an international safety standard.

The SFI Foundation is a non-profit organisation based in the USA and was established to issue and administer standards for specialty/performance automotive and racing equipment. The SFI Foundation operates a test laboratory dedicated to the evaluation of safety products and has an extensive list of tested and approved racing apparel and equipment.

You can find out more about the SFI Foundation at [www.sfifoundation.com](http://www.sfifoundation.com)



The Speedway Safety Committee was formed in 2006 to give advice and provide guidelines to the Speedway Australia Board on relevant aspects of safety and competition regulation in Australian Speedway.

It is designed to liaise closely with national and international technical associations and provide safety reports at the National Safety Conference.

Topics on their agenda include

- Personal safety equipment
- Seats and seatbelts
- Helmets and head restraints
- Track specifications
- Vehicle comparisons

The committee includes people from around Australia with a vast combined knowledge of the sport, who are also up to date with the latest safety trends and information.

All Speedway Australia Insured Tracks undergo a safety inspection and assessment and are issued a rating from One Star (lowest) to Five Star (highest).

Star ratings are dependent on the types of safety facilities that the track has in place including track safety fence, construction material, catch fence posts and cables, dimensions and crowd control fence. Star Ratings are used to determine what level of Speedway Events may be held at the venue.

### **Track Inspections**

As part of the Track Safety and Rating Scheme, track inspections are conducted at all venues every 2 years.

Speedway Australia in recent years has implemented a new discount rating scheme for tracks enabling them to apply for benefits in return for improving safety at their venue.

The data collected from tracks regarding safety will cover all aspects of the venue, from competitors and spectators to officials and volunteers, and will reward the venues with discounts and better ratings for complying with policies set out by Speedway Australia.



**[WWW.SPEEDWAYAUSTRALIA.ORG](http://WWW.SPEEDWAYAUSTRALIA.ORG)**

The Speedway Australia Gold Card was created in conjunction with affiliated venues to reward the champions of our national categories.

When a currently licensed driver wins an Australian Title in an officially sanctioned Speedway Australia National Division, they will be awarded with a Speedway Australia Gold Card.

The Gold Card entitles the holder to a complimentary 12 month Speedway Australia competitor licence in addition to one admission per event when competing at Speedway Australia tracks.

## Current Australian Champions

<i>Division</i>	<i>Current Champion</i>
AMCA Nationals	Matt Hardy (QLD)
SSA Junior Sedans	Harrison Beres (WA)
SSA Modified Sedans	Nathan Macdonald (QLD)
SSA Prod Sedans	Josh Harm (QLD)
SSA Street Stocks	Nathan Thorne (SA)
SSA Super Sedans	Joel Berkley (QLD)
Modlites	Terry Leerentveld (QLD)
Formula 500s	Event Not Held
Late Models	Kye Blight (WA)
SKAA Karts	Event Not Held
Speedcars	Kaidon Brown (NSW)
Sprintcars	James McFadden (VIC)
360/LS Sprintcars	Lachlan McHugh (QLD)
V8 Dirt Modifieds	Kevin Britten (QLD)
Wingless Sprints	Tyson Martin (SA)

Speedway Australia offers grant funding to tracks, associations, clubs and venues on a number of levels to assist in the growth of the sport.

## Track Grants

Track support has increased in recent years, with funding this season changing from a safety to a COVID-recovery focus.

## National Division Support

In addition to specific divisional body financial assistance, Speedway Australia attends all National titles to assist the host venue and division with resourcing and support.



## Grassroots Grants

Speedway Australia will consider other requests for assistance from tracks on a case-by-case basis.

In 2006 Speedway Australia formed the National Speedway Induction Committee consisting of competitors, promoters, media members, historians and vintage association members

from all mainland states of Australia to nominate and select eligible candidates for induction into the Hall of Fame.



## AUSTRALIAN SPEEDWAY HALL OF FAME

<p><b>ED 2007</b> LE ANDERSON RTHUR NYTHON CKAY MCGEE GRO VELL RUSH Y STEWART E TATNELL</p> <p><b>ED 2008</b> RITON REEMAN AYMOND SHERWOOD SIDNEY VAN PRAGG GZELL ER WILKINSON YOUNG</p> <p><b>CTED 2009</b> E BRAZER CRUMP WIES DIX R DODD FENTON</p>	<p>KEVIN FISCHER PETER GURBEL HARRY NEALE ALEX ROWE</p> <p><b>INDUCTED 2011</b> SIR JACK BRABHAM JOHN BOULDER ALAN FELSCH MICHAEL FIGLIOMENI BILL GOODE SID HOPPING GRAEME McCUBBIN GEOFF MURPHY DENNIS NASH/JEFF GITTUS BLAIR SHEPHERD FRED TRACEY</p> <p><b>INDUCTED 2016</b> NEVILLE HARPER PETER WHITE JOHN ANDERSSON RON WANLESS MAX DUMESNY</p>
--	---

In 2007, during a magical and emotional evening in the Bradman Room at the Adelaide Oval, the inaugural Hall Of Fame dinner saw 10 legendary drivers, promoters, car owners and constructors inducted into the Australian Speedway Hall of Fame.

11 years later there have now been seven induction ceremonies, with 61 speedway legends having received recognition.

To view a full list of all inductees to the Speedway Australia Hall of Fame visit our website [www.speedwayaustralia.org](http://www.speedwayaustralia.org)

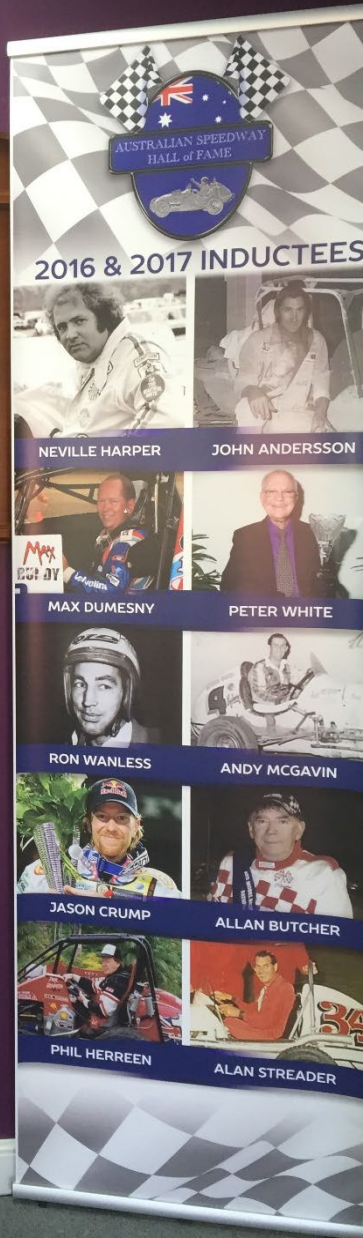

The Australian Speedway Awards are held annually, to celebrate the high achievers across the sport in each season.

A total of 12 Awards are presented in the following categories:

- Track of the Year
- Most Improved Track of the Year
- Marshal/Volunteer of the Year
- Photographer of the Year
- Innovation/Promotional Item/Event of the Year
- Media Person/Group/Outlet of the Year
- Competitor of the Year: Open Wheel
- Competitor of the Year: Sedan
- Competitor of the Year: Modified
- Competitor of the Year: Karting
- Competitor of the Year: Junior
- Overall Speedway Sportsperson of the Year

The winners of these awards are determined by a panel of judges.

To nominate a worthy individual or organisation for an award go to [www.speedwayawards.org](http://www.speedwayawards.org) or [click here](#) to view the page.





**STATE INFORMATION:  
TRACKS & CLASSES**

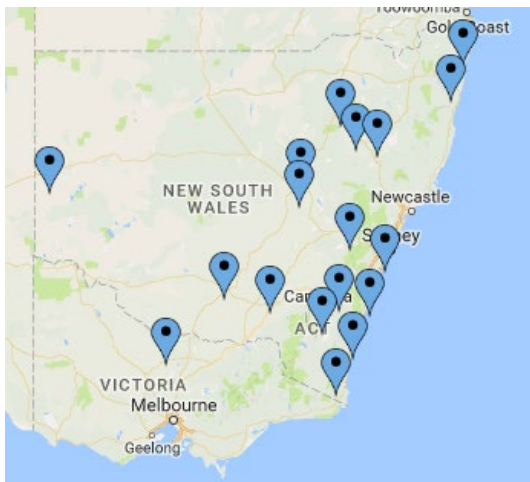

## TRACKS

ACT Speedway, Canberra  
 Brobenah Raceway, Leeton  
 Broken Hill Speedway  
 Cullen Bullen Raceway  
 Gilgandra Speedway  
 Goulburn Speedway  
 Grafton Speedway  
 Gunnedah Speedway  
 Heartland Raceway, Moama

Lismore Speedway  
 Moruya Speedway  
 Morris Park Speedway, Dubbo  
 Northwest Speedway, Narrabri  
 Nowra Speedway  
 Oakburn Park, Tamworth  
 Sapphire Speedway, Bega  
 Sydney Speedway

## STATE DIVISIONS

RSA 4 Cylinder Sedans  
 Compact Speedcars  
 RSA Fender Benders  
 GP Midgets  
 Legend Cars  
 Lightning Sprints  
 RSA Super Production

Microsprints  
 Outlaw Karts  
 RSA Street Stockers  
 RSA Outlaw Sedans  
 RSA Junior Sedans  
 Stockcars

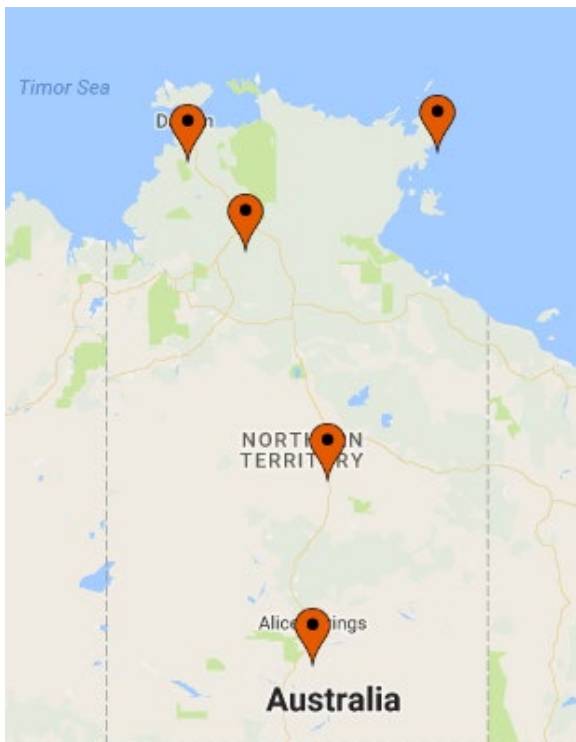

**TRACKS**

- Arunga Park Speedway, Alice Springs
- Katherine Speedway
- Nhulunbuy Speedway
- Northline Speedway, Darwin
- Tennant Creek Speedway

**STATE DIVISIONS**

NT Sedans

NT Bombers



## TRACKS

Bowen Speedway, Bowen  
 Cairns International Speedway  
 Coal Capital Speedway, Blackwater  
 Lockyer Valley Speedway, Gatton  
 McCosker Gladstone Speedway  
 Hi-Tec Oils Speedway, Toowoomba  
 Mareeba Speedway  
 Kingaroy Speedway  
 Maryborough Speedway  
 Mothar Mountain Speedway, Gympie  
 Moranbah Speedway  
 Pioneer Park Speedway, Ayr  
 Rockhampton Speedway  
 Roma Speedway  
 Sun State Speedway Karts, North Brisbane

## STATE DIVISIONS

Compact Speedcars	Lightning Sprints
Formula 250	Outlaw Karts incl Juniors
Formula 400	RSA 4 Cylinder Sedans
Microsprints	RSA Outlaw Sedans
SSA Nostalgia Sedan	RSA Fender Benders
Surfers Paradise Sedans	RSA Super Production
Legend Cars	RSA Street Stockers
Stock Cars	RSA Junior Sedans
Super Stockers	
SSA Super Street Sedans	



## **TRACKS**

Borderline Speedway, Mt Gambier  
Murray Machinery & Sheds Speedway, Murray Bridge  
Riverland Speedway, Renmark  
South Australian Vintage Speedcar Assn, Gillman  
Sunline Speedway, Waikerie  
Tolmer Speedway, Bordertown  
Whyalla Speedway Club Inc, Whyalla

## **STATE DIVISIONS**

Legend Cars  
Limited Sportsmen  
Outlaw Karts incl Juniors  
V6 Sprints

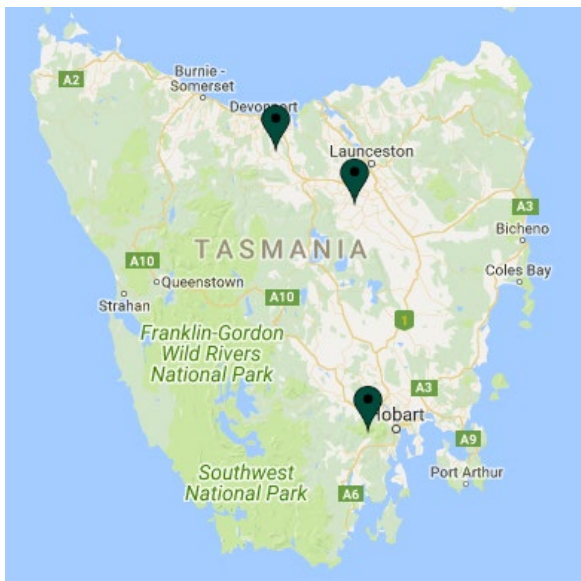

**TRACKS**

Cranes Combined Carrick Speedway, Carrick  
AutoKlene Hobart Raceway, Hobart  
Gulf Western & Independent Oils Raceway, Latrobe

**STATE DIVISIONS**

SSA Tassie Bombers  
SSA Tassie Sixes  
Outlaw Karts incl Juniors

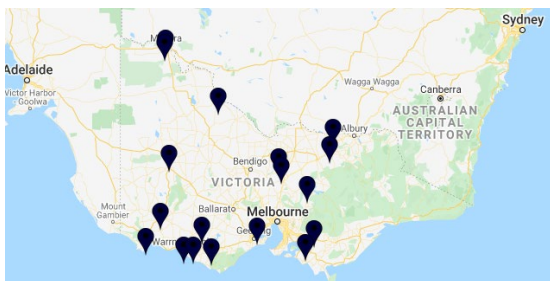

## TRACKS

Alexandra Speedway  
 Avalon Raceway, Geelong  
 Bairnsdale Speedway  
 Blue Ribbon Raceway, Kalkee  
 Daylesford Speedway  
 Drouin Speedway, Drouin West  
 Laang Speedway  
 Mid-Western Speedway, Darlington  
 Nagambie Speedway  
 Nyora Raceway  
 Redline Raceway, Ballarat  
 Premier Speedway, Warrnambool  
 Rosedale Speedway  
 Rushworth Speedway, Rushworth  
 Simpson Speedway  
 Southern 500 Speedway, Portland  
 Sunraysia Dirt Karters Inc, Mildura  
 Swan Hill Speedway, Swan Hill  
 Timmis Speedway, Mildura  
 Wahgunyah Speedway  
 Wangaratta City Speedway  
 Western Speedway, Hamilton

## STATE/CLUB\* DIVISIONS

Crash & Bash	VSC Division 2 Hot Rods
Compact Speedcars	VSC GOS Sedans
GP Midgets	VSC Limited Sportsmen
*GV Mods	VSC SDAV Hot Rods
*GV Production Sedans	VSC Super Rods
Legend Cars	VSC Unlimited Sedans
Lightning Sprints	VSC Sports Sedans
*Daylesford A Mod/B Mod	VSC Minisprints
*Daylesford Street Stocks	VSC Formula 500
Outlaw Karts incl Juniors	VSC Standard Saloons incl. Jnr
*Nagambie Dirt Karts	V8 Trucks



## TRACKS

Albany Speedway  
Broome Speedway  
Bunbury Speedway  
Carnarvon Speedway  
Derby Speedway  
Collie Speedway  
Ellenbrook Speedway  
Esperance Speedway  
Geraldton City Speedway  
Hillview Speedway, Newman  
Kalgoorlie International Speedway  
Kellerberrin Speedway  
Kununurra Speedway  
Manjimup Speedway  
Margaret River Speedway  
Moora Speedway  
Mt Barker Speedway  
Narrogin Speedway  
Nickol Bay Speedway, Karratha  
Perth Motorplex  
Pithara Speedway  
Shark Bay Speedway  
Port Hedland Speedway

## STATE DIVISIONS

Formula 125s incl. Juniors  
Legend Cars  
Limited Sprintcars  
LS1 Sprintcars  
Outlaw Karts incl Juniors  
Super Mods  
Super Six